

User's Manual

ICP Controllers of the GDT RS and RN Series

32-Bit / 64-Bit PCI

Ultra2 SCSI and Ultra 160 SCSI

RAID Controllers

1st Edition

© Copyright 1998-2000

ICP vortex Computersysteme GmbH
Konrad-Zuse-Str. 9
74172 Neckarsulm - Germany

ICP vortex Corporation
4001 E. Broadway / B-20
Phoenix, AZ 85040, USA

All Rights and Changes Reserved.

01





Contents - Overview

Part I

Chapter A	General Information
Chapter B	Hardware Installation
Chapter C	Quick-Setup

Part II

Chapter D	Using Microsoft MS-DOS, Windows 95/98
Chapter E	Using Novell NetWare
Chapter F	Using Windows NT/2000
Chapter G	Using LINUX
Chapter H	Using SCO UNIX
Chapter I	Using UnixWare

Part III

Chapter J	The ICP RAID Console
Chapter K	The ICP RAID Navigator
Chapter L	Appendix

Limited Warranty

ICP vortex Corporation ("ICP vortex") guarantees that this product is free from defects in material and workmanship. Subject to the conditions and limitations set forth below, ICP vortex will, at its own option, either repair or replace any part of this product which proves to be defective by reasons of improper workmanship or materials. Parts used to repair products or replacement products will be provided by ICP vortex on an exchange basis, and will be either new or refurbished to be functionally equivalent to new.

This warranty does not cover any damage to this product, which results from accident, abuse, misuse, natural or personal disaster, Acts of God, or any unauthorized disassembly, repair or modification. The duration of this warranty is one year from the date of original retail purchase.

Warranty Claim Requirements

To obtain warranty service, return the defective product, freight prepaid and insured, to your local authorized ICP vortex dealer or distributor, or to ICP vortex Corporation, 4001 E. Broadway, B-20, Phoenix, AZ 85040. Please note the following: You must include the product serial number, and a detailed description of the problem you are experiencing. You must also include proof of the date of original retail purchase as evidence that the product is within the warranty period.

If you need to return the product to ICP vortex, you must first obtain a Return Material Authorization (RMA) number by calling ICP vortex Corporation at 602-414-0414. This RMA number must be displayed on the outside of your package. Products must be properly packaged to prevent damage in transit. ICP vortex accepts no responsibility for products which are damaged on arrival due to poor freight service.

Disclaimers

The foregoing is the complete warranty for ICP vortex products and supersedes all other warranties and representations, whether written or oral. Except as expressly set forth above, no other warranties are made with respect to ICP vortex products. ICP vortex expressly disclaims all warranties not stated herein, including, to the extent permitted by applicable law, any implied warranty of merchantability or fitness for a particular purpose. In no event will ICP vortex be liable to the purchaser, or to any user of the ICP vortex product, for any data loss, data corruption, damages, expenses, lost revenues, lost savings, lost profits, or any other incidental or consequential damages arising from the purchase, use or inability to use the ICP vortex product, even if ICP vortex has been advised of the possibility of such damages.

ICP vortex is not liable for, and does not cover under warranty, any costs associated with servicing and/or installation of ICP vortex products.

This manual has been validated and reviewed for accuracy. The sets of instructions and descriptions were accurate for ICP Disk Array Controllers at the time of this manual's production. However, succeeding Controllers, software and manuals are subject to change without notification. Therefore, ICP vortex assumes no liability for damages incurred directly or indirectly from errors, omissions or discrepancies between the Controller, software and the manual.



Pick up the phone



**if you need technical support
and dial the numbers:**

For Europe: +49-(0)7132-9620-900

For the USA: 602-414-0414

or send us a FAX:

For Europe:

+49-(0)7132-9620-400

For the USA: 602-414-0444

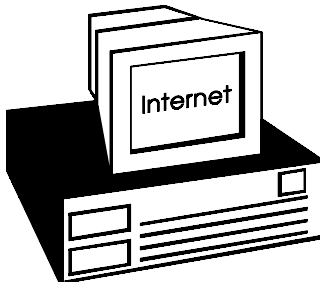
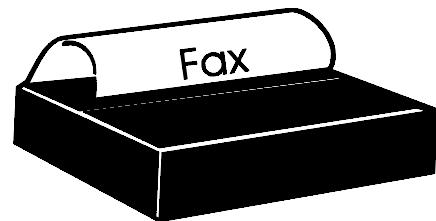

or send us an E-Mail:

For Europe: support@vortex.de

For the USA: support@icp-vortex.com

or check our Website:

<http://www.icp-vortex.com>

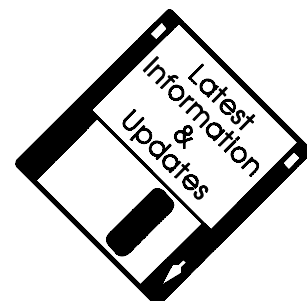

Important Note

Using modern RAID Systems significantly increases data security and availability. *Under no circumstances* does it relieve you from a careful and daily backup on tape or a similar backup media. This is the only method to protect your valuable data against total loss (e.g., through fire or theft), accidental deletion, or any other destroying impacts.

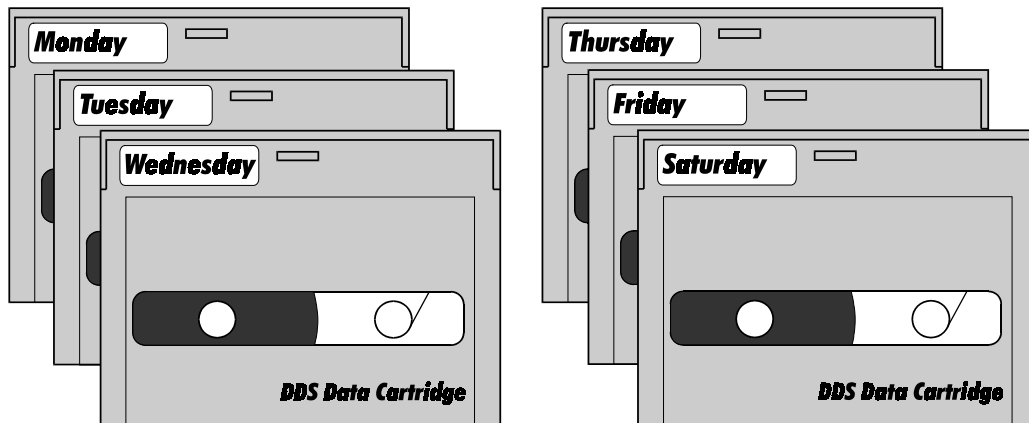

Many Thanks to all my Friends

Monika & Wolfgang (the grandmasters)
AnnDee, Lois, Jeniffer, Valerie, Carl, Frank, Ken (the right one) and William (the Phoenix Crew)
Achim, Dieter, Günter, Hooshar, Johannes, Jörg, Norbert, Otto, Ralph, Sam, Steffen, Winfried
Brigitte, Alfred (AB, "We need clustering. I say we have it") and Ruediger
Andreas (AK, or "Kopf nur mit ö")
Michael (Mipf, "where is my CPU ?")
Jürgen (Jogo, "Hi, is Jurgen there ?")
Jürgen (JB, "diesbezüglich & hinsichtlich or probably")
Markus (Malu, "Luuuuu..."), Uwe, Ralf

All the fantastic "rest" of this incredible company.

It is not only a pleasure to work here, it is a passion.

FCC Compliance Statement

Information for the User

NOTE: This equipment has been tested and found to comply with the limits for a Class B digital device, pursuant to Part 15 of the FCC Rules. These limits are designed to provide reasonable protection against harmful interference in residential installations. This equipment generates, uses, and can radiate radio frequency energy, and if not installed and used in accordance with the instructions, may cause harmful interference to radio communications. However, there is no guarantee that interference will not occur in a particular installation. If this equipment does cause harmful interference to radio or television reception, which can be determined by turning the equipment off and on, the user is encouraged to try to correct the interference by one or more of the following measures:

- Reorientate or relocate the receiving antenna.
- Increase the separation between the equipment and the receiver.
- Plug the equipment into an outlet on a circuit different from that to which the receiver is powered.
- If necessary, consult the dealer or an experienced radio/T.V. technician for additional suggestions.

The use of a non-shielded interface cable with the referenced device is prohibited. Changes or modifications not expressly approved by ICP vortex Computersysteme GmbH could void the authority to operate the equipment.

Table of Contents

A. Introduction.....	16
A.1 Product Identification	16
A.1.1 Key Features of the ICP Controllers of the GDT RS and RN Series.....	17
A.2 Copyrights, Patents	19
A.3 Software License Agreement.....	20
A.4 General Information	21
A.4.1 Unpacking the ICP Controller.....	21
A.4.2 Delivery Contents	21
A.4.3 Contents of the ICP CDROM.....	21
A.4.4 Before You Start	21
A.5 Product Description	22
A.5.1 Intel i960RS or i960RN I/O Processor.....	22
A.5.2 64 Bit Architecture.....	22
A.5.3 Cache RAM - Expandable to 128MB	22
A.5.4 Compatibility - PCI.....	22
A.5.5 Up to 6 Ultra 160 SCSI Channel.....	22
A.5.6 ICP Controller Firmware, BIOS and ICP RAID Console.....	22
A.5.7 Configuration and Monitoring utilities "ICP RAID Console" and "ICP RAID Navigator" Program ICPCON....	23
A.5.8 Operating System Driver Software	25
A.5.9 ICP Controller Board Layout	25
B. Hardware Installation.....	36
B.1 Before Installation	36
B.2 Tools.....	36
B.3 Installing the PC100 DIMM Module.....	36
B.4 SCSI - Basics.....	37
B.4.1 SCSI Cables.....	38
B.4.2 SCSI Termination.....	43
B.4.3 SCSI ID.....	43
B.4.4 ICP SCSI Accessories.....	44
B.4.5 Examples.....	46
B.6 ICP Controller Function Check.....	49
B.6.1 PCI 2.2 Compatibility Requirements	49
B.6.1 Trouble Shooting	51
B.6.2 Checking the ICP Controller Configuration.....	51

C. Quick-Setup	54
C.1 What is the Aim of Quick-Setup ?	54
C.2 What is the ICP Controller Firmware ?	54
C.2.1 The Different RAID Levels	56
C.2.2 Levels of Hierarchy Within the ICP Firmware	59
C.2.3 Using CD-ROMs, DATs, Tapes, etc.	60
C.3 Example 1 - Installing a Single SCSI Hard Disk.....	60
C.4 Example 2 - Installing a Mirroring Array - RAID 1	62
C.5 Example 3 - Installing a RAID 5 Disk Array.....	63
C.6 Trying to Answer The Initial Questions.....	65
C.6.1 How Many Hard Disks Should be Integrated Into the Disk Array ?.....	65
C.6.2 Which Level of Redundancy is Needed ?.....	66
C.6.3 Do we Need Hot Fix drives ?.....	66
C.7 States of a RAIDYNE® Disk Array	67
C.7.1 "Idle" State	67
C.7.2 "Build" State	67
C.7.3 "Ready" State.....	67
C.7.4 "Fail" State	67
C.7.5 "Rebuild" State.....	67
C.7.6 "Expand" State	67
C.7.7 "Error" State.....	67
C.8 Methods for the Replacement of a Disk Drive	69
D. Using Microsoft MS-DOS	72
D.1 Transparency of Host Drives.....	72
D.2 Partitioning a Host Drive and Transferring MS-DOS.....	72
D.3 CONFIG.SYS and the Driver GDTX000.EXE	72
D.4 Expanded Memory Managers.....	73
D.5 Using a CDROM Drive under MS-DOS	74
D.5.1 Example: Using the ASW Software for the CDROM	75
D.5.2 Example: Using corelSCSI for the CDROM.....	75
D.6 The ICP ASPI Manager GDTASPI.EXE.....	76
D.6.1 Using ASW ASPIDISK.SYS	77
D.6.2 Using corelSCSI	77
D.7 Installing Windows 95	78
D.7.1 The ICP Controller is the primary controller	78
D.7.2 The ICP Controller is the secondary controller.....	79
D.7.3 Update the ICP Windows 95 Driver.....	79

D.8	Installing Windows 98	80
E.	Using Novell NetWare	82
E.1	Transparency of Host Drives	82
E.2	Novell NetWare 3.10, 3.1, 3.12 and 3.20	82
E.3	Novell NetWare 4.x – Using "DSK" Driver	82
E.4	Novell NetWare 4.x/5.x – Using "HAM" Driver.....	83
E.5	Tips and Tricks.....	85
E.5.1	Optimize Data Throughput	85
E.5.2	'cache memory allocator out of available memory' in PCI-ISA Systems	85
E.5.3	Installing NetWare 4.1 - Wrong Drive Name	86
E.5.4	NetWare-Server Not Stable When High Utilization	86
E.5.5	ICP Controller and Non-ASPI Compatible Controllers	86
E.5.6	Last Status Information	87
E.5.7	Adding Additional Capacity After An Online Capacity Expansion	87
E.6	Notes on ARCserve	87
F.	Using Microsoft Windows NT or Windows 2000.....	90
F.1	Transparency of Host Drives	90
F.2	Windows NT	90
F.2.1	Preparing the Installation	90
F.2.2	The Installation.....	92
F.2.2.1	The ICP Controller is the first Controller in the System	92
F.2.2.2	The ICP Controller is the Secondary Controller in the System	92
F.2.3	Using the Hot Plug Function with RAID Host Drives	93
F.2.4	Installation of a new GDTX.SYS Driver Version.....	93
F.2.5	Installation of a Removable Hard Disk	93
F.2.6	Adding Additional Capacity After An Online Capacity Expansion	94
F.2.7	Update Windows NT -> Windows 2000	94
F.3	Windows 2000.....	94
F.3.1	Preparing the Installation	94
F.3.2.1	The ICP Controller is the first Controller in the System	95
F.3.2.2	The ICP Controller is the second Controller in the System	95
G.	Using LINUX.....	98
G.1	Transparency of Host Drives	98
G.2	Available Drivers and Tools.....	98
G.3	Updating the driver using the driver sources	98
G.4	Driver installation or update using a patch	98
G.5	ICPCON – Configuration and Monitoring Tool	99

G.6	gdth driver parameters	100
G.7	Notes	101
H.	Using SCO UNIX V/386.....	104
H.1	Transparency of Host Drives.....	104
H.2	General Tips for Installation.....	104
H.3	Instructions on mkdev (ADM) for 3.2v4.x.....	105
H.4	Instructions on mkdev (ADM) for 3.2v5.x (Open Server).....	108
H.5	Further Information	109
I.	Using UnixWare.....	112
I.1	Transparency of Host Drives.....	112
I.2	General Installation Notes	112
I.3	ICP Controller as Boot Controller.....	112
I.4	ICP Controller as an additional Controller	113
I.5	Coordinates of SCSI devices	113
I.6	Further Information.....	114
J.	The Program ICPCON	116
J.1	Loading ICPCON	116
J.1.1	Loading the ICPCON Program Under NetWare	116
J.1.2	Loading the ICPCON Program Under Solaris 7	117
J.1.3	Loading the ICPCON Program Under Windows NT / 2000.....	117
J.1.4	Loading the ICPCON Program Under Windows 95/98	117
J.1.5	Loading ICPCON Under SCO UNIX	117
J.1.6	Loading ICPCON Under LINUX	118
J.2	The ICPCON Program	118
J.2.1	Select Interface	119
J.2.2	Select Controller	120
J.2.3	The two Menu Areas "Monitor" and "Express/Advanced Setup".....	120
J.3	The Menu Monitor	121
J.3.1	Menu Monitor: View Statistics.....	121
J.3.2	Menu Monitor: View Events	122
J.3.3	Menu Monitor: View Hard Disk Info.....	122
J.3.4	Menu Monitor: Save Information	123
J.4	The Menu Express/Advanced Setup	124
J.4.1	Menu Express Setup: Configure Host Drives.....	124
J.4.2	Menu Express Setup: Repair Array Drives	128
J.4.3	Menu Advanced Setup: Configure Controller	130

J.4.3.1	Menu Advanced Setup: Configure Controller, Controller Settings.....	130
J.4.3.2	Menu Advanced Setup: Configure Controller, Firmware Update	131
J.4.3.3	Menu Advanced Setup: Configure Controller, Intelligent Fault Bus.....	131
J.4.3.4	Menu Advanced Setup: Conf. Controller, Non-Intelligent Enclosures.....	131
J.4.3.5	Menu Advanced Setup: Configure Controller, Advanced Settings.....	133
J.4.3.6	Menu Advanced Setup: Configure Controller, Cluster Settings.....	133
J.4.3.7	Menu Advanced Setup: Configure Controller, Clear Log Buffer	133
J.4.4	Menu Advanced Setup: Configure Physical Devices.....	133
J.4.4.1	Menu Advanced Setup: Configure Phys. Devs., SCSI Parameter /Initialize	135
J.4.4.2	Menu Advanced Setup: Configure Phys. Devs., Format Disk	136
J.4.4.3	Menu Advanced Setup: Configure Phys. Devs., Check Surface	136
J.4.4.4	Menu Advanced Setup: Configure Phys. Devs., View Status/Defects.....	136
J.4.4.5	Menu Advanced Setup: Configure Phys. Devs., Deinitialize Disk	136
J.4.4.6	Menu Advanced Setup: Configure Phys. Devs., Lock/Unlock Disk.....	137
J.4.4.7	Menu Advanced Setup: Configure Phys. Devs., Enclosure Status.....	137
J.4.5	Menu Advanced Setup: Configure Logical Drives	139
J.4.6	Menu Advanced Setup: Configure Array Drives.....	140
J.4.6.1	Menu Advanced Setup: Configure Array Drives, Change Drive Name	141
J.4.6.2	Menu Advanced Setup: Configure Array Drives, Expand Array Drive	141
J.4.6.3	Menu Advanced Setup: Configure Array Drives, Add RAID 1 Component.....	141
J.4.6.4	Menu Advanced Setup: Configure Array Drives, Replace Array Component.....	141
J.4.6.5	Menu Advanced Setup: Configure Array Drives, Remove RAID 1 Component	141
J.4.6.6	Menu Advanced Setup: Configure Array Drives, Remove Array Drive.....	142
J.4.6.7	Menu Advanced Setup: Configure Array Drives, Add Hot Fix Drive.....	142
J.4.6.8	Menu Advanced Setup: Configure Array Drives, Remove Hot Fix Drive	143
J.4.6.9	Menu Advanced Setup: Configure Array Drives, Hot Fix Pool Access	143
J.4.6.10	Menu Advanced Setup: Configure Array Drives, Parity Verify	143
J.4.6.11	Menu Advanced Setup: Configure Array Drives, Parity Recalculate	143
J.4.6.12	Menu Advanced Setup: Configure Array Drives, Build/Rebuild Progress.....	143
J.4.6.13	Menu Advanced Setup: Configure Array Drives, Create new Array Drive	144
J.4.7	Menu Advanced Setup: Configure Host Drives.....	145
J.4.7.1	Menu Advanced Setup: Configure Host Drives, Change Drive Name	146
J.4.7.2	Menu Advanced Setup: Configure Host Drives, Swap Host Drives.....	146
J.4.7.3	Menu Advanced Setup: Configure Host Drives, Remove Host Drives	146
J.4.7.4	Menu Advanced Setup: Configure Host Drives, Split Host Drive	146
J.4.7.5	Menu Advanced Setup: Configure Host Drives, Merge Host Drives.....	146
J.4.7.6	Menu Advanced Setup: Configure Host Drives, Partition Host Drives	146
J.4.7.7	Menu Advanced Setup: Configure Host Drives, Overwrite Master Boot Code.....	146
J.4.7.8	Menu Advanced Setup: Configure Host Drives, Drive Type (Cluster).....	146
K.	ICP RAID Navigator	148

K.1 Introduction	148
K.2 The ICP RAID Navigator "Controls"	149
K.2.1 The Toolbar	149
K.2.2 The Status Bar	149
K.2.3 "Window" Menu Commands	149
K.2.4 "Help" Menu Commands	150
K.2.5 "File" Menu Commands	150
K.2.6 "View" Menu Commands	150
K.2.7 The "Chart" Menu	151
K.2.8 The "Configuration" Menu Commands	151
K.3 Select Controller	152
K.4 Physical Configuration Window	152
K.4.1 Controllers	153
K.4.2 I/O Processors	155
K.4.3 Direct Access Devices	156
K.4.4 Non direct access devices (raw devices)	160
K.5 Logical Configuration Window	161
K.5.1 The Host Drive Information Window	164
K.5.2 The Array Drive Information Window	164
K.5.3 The Logical Drive Information Window	166
K.5.4 Change the name of a Drive	167
K.5.5 Remove a Host Drive	167
K.5.6 Create a new Host Drive	167
K.5.7 Parity Verify	168
K.5.8 Parity Recalculate	168
K.5.9 Progress Information	169
K.5.10 Expansion of an Array	169
K.5.11 Add a Hot Fix Drive	170
K.5.12 Remove a Hot Fix Drive	171
K.5.13 Hot Fix Pool Access	171
K.5.14 Add a RAID 1 Component (Mirror a Drive)	171
K.5.15 Remove a RAID 1 Component (Remove a Mirror Drive)	172
K.5.16 Replace a Logical Drive	172
K.5.17 The Different States of an Array Drive	172
K.6 The Statistics Window	175
K.7 The Controller Events Window	176
K.8 ICP RAID Navigator Help	177
K.9 ICP Service and ICP Mail	178
L. Appendix	184

L.1 Technical Data of the ICP Controller..... 184
L.2 Boot Error Messages 184
L.3 Index 185

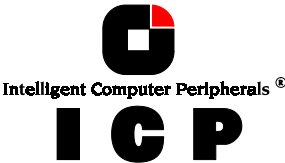

Chapter A

General

Information

A. Introduction

GDT RN Series: 64 Bit PCI hardware RAID Disk Array Controllers with up to 3 Wide/Ultra2 SCSI or up to 6 Ultra 160 SCSI channels

GDT RS Series: 32 Bit PCI hardware RAID Disk Array Controllers with up to 3 Wide/Ultra2 SCSI channels

In order to take full advantage of modern operating systems, high performance computer systems are needed. When assessing the performance of a computer system, the aspects speed and security of the mass-storage subsystem are gaining increasing importance. As a result of the constantly growing acceptance of the RAID technology (Redundant Array of Independent Disks) in these computer systems, and the identification of the RAID controller as the essential part of a disk subsystem, a strong demand for suitable RAID controllers has emerged during the past few years.

Since 1990, ICP vortex has been intensively engaged in the research and development of RAID products for the highest performance and security requirements. Due to our products' outstanding performance, our expertise and continuity in development, ICP Controllers are accepted and known as top leading-edge products all over the world. ICP Controller products within the GDT RS and RN Series are suitable for the most different platforms and applications. All ICP Controllers are *pure-bred hardware solutions*.

All functionality required for the very complex tasks is hardware-implemented on the controller. Thus, RAID is fully independent of the computer system (the host) and the operating system. Thanks to the wide operating system support and easy-to-use installation and maintenance utilities, setting up and using high performance and fault-tolerant mass-storage subsystems for almost every purpose is child's play.

We would like to thank you for purchasing an ICP Controller.

ICP - Intelligent Computer Peripherals®

A.1 Product Identification

In order to meet the various customer and system requirements, ICP vortex offers various RS and RN Series Disk Array Controllers for 32 Bit and 64 Bit PCI computer systems. The main differences between the controllers lie in PCI bus width, the number of Wide/Ultra2 and Ultra1 160 SCSI channels, the supported RAID levels and the Clustering Support. All Wide/Ultra2 SCSI models of the RN Series feature an additional Wide/Ultra SCSI channel for legacy SCSI devices.

GDT RS Series, 32-Bit PCI Bus (Controllers can be operated in a 32-Bit and 64-Bit PCI Bus)

ICP Controller Name	Number of Wide/Ultra2 SCSI channels	Supported RAID Levels
GDT6118RS	1	0/1
GDT6128RS	2	0/1
GDT6518RS	1	0/1/4/5/10
GDT6528RS	2	0/1/4/5/10
GDT6538RS	3	0/1/4/5/10

GDT RN Series, 64-Bit PCI Bus (Controllers can be operated in a 32-Bit and 64-Bit PCI Bus) with Wide/Ultra2 SCSI channels

ICP Controller Name	Number of Wide/Ultra2 SCSI channels	One Wide/Ultra SCSI channel	Clustering Support	Supported RAID Levels
GDT7118RN	1	Yes	Optional	0/1
GDT7128RN	2	Yes	Optional	0/1
GDT7518RN	1	Yes	Optional	0/1/4/5/10
GDT7528RN	2	Yes	Optional	0/1/4/5/10
GDT7538RN	3	Yes	Optional	0/1/4/5/10
GDT7618RN	1	Yes	Yes	0/1/4/5/10
GDT7628RN	2	Yes	Yes	0/1/4/5/10
GDT7638RN	3	Yes	Yes	0/1/4/5/10

GDT RN Series, 64-Bit PCI Bus (Controllers can be operated in a 32-Bit and 64-Bit PCI Bus) with Wide/Ultra 160 SCSI channels

ICP Controller Name	Number of Wide/Ultra 160 SCSI channels	Transferrate per Wide/Ultra 160 SCSI channels	Clustering Support	Supported RAID Levels
GDT7123RN	2	160 MB/s	Optional	0/1
GDT7523RN	2	160 MB/s	Optional	0/1/4/5/10
GDT7543RN	4	160 MB/s	Optional	0/1/4/5/10
GDT7563RN	6	160 MB/s	Optional	0/1/4/5/10
GDT7623RN	2	160 MB/s	Yes	0/1/4/5/10
GDT7643RN	4	160 MB/s	Yes	0/1/4/5/10
GDT7663RN	6	160 MB/s	Yes	0/1/4/5/10

A.1.1 Key Features of the ICP Controllers of the GDT RS and RN Series

- 64 Bit Hardware RAID Controllers with RAID 0/1, or RAID 0/1/4/5/10 Array Drives at controller level, completely independent of the computer system and the operating system. Several Array Drives can be operated simultaneously.
- Operation in 64 Bit and 32 Bit PCI slots. Full Bus Mastering. Maximum data transfer rates: 132MB/sec in a 32 Bit PCI slot and 264MB/sec in a 64 Bit PCI slot (with RN Series, only).
- "Private" (i.e., for one Array Drive) or "Pool" (i.e., for several Array Drives) Hot Fix Drives.
- Online Capacity Expansion. Add one or several new disk drives to an existing Array Drive to expand its capacity. During the Expansion all data are redundant.
- Online RAID Level Migration. Online change of an Array Drive's RAID Level, e.g., from RAID 0 to RAID 5.
- Online Capacity Expansion and RAID Level migration can be performed simultaneously.

- ROM-resident character-based configuration and monitoring utility **ICP RAID Console** . Express Setup option to easily setup Array Drives. Press "CTRL-G" to load ICPCON, long before the operating system is booted. ICPCON is also available as an executable program under the various supported operating systems.
- **ICP RAID Navigator**. GUI-style configuration and monitoring utility for Windows 95/98/NT/2000.
ICPCON. Character oriented program for Windows 95/98/NT, NetWare, Linux, SCO UNIX, UnixWare. Both tools allow the configuration and monitoring of ICP Controllers with their array drives.
Remote operation. Intelligent messaging.
- On-Board i960Rx © Intelligent 64 Bit I/O Processor (100MHz). Completely offloads the host CPU.
- Up to three Wide/Ultra2 SCSI or up to six Ultra 160 SCSI channels with onboard multi-mode (LVD/SE) termination. Up to 80MB/s data transfer rate per Wide/Ultra2 SCSI channel and 160MB/s per Ultra 160 SCSI channel.
- Up to 12 meters cable length per Wide/Ultra2 or Ultra 160 SCSI channel.
- For the Wide/Ultra2 SCSI RN Series Controllers one full-featured additional Wide/Ultra SCSI channel for legacy SCSI devices (hard disks, CDROMs, etc.) with third generation 32 SCSI RISC processor and an active, software-switchable termination. Dual connector system (50 pin and 68 pin connector). Synchronous data transfer rate up to 40MB/sec.
- Cache RAM: 16MB, 32MB, 64MB, or 128MB. Standard non-buffered PC100 DIMM Module, with or without ECC. Automatic Cache RAM detection.
- Intelligent multi-level cache-algorithm with adaptive delayed write and read ahead functions. This ensures an optimized cache for various load profiles and system requirements.
- On-Board PCI 2.2 compatible BIOS (Plug & Play).
- BIOS, Firmware and ICPCON in Flash-RAM. Easy update.
- Drivers for MS-DOS, Novell NetWare, SCO UNIX V/386, UnixWare, Linux, Windows NT, Windows 95/98 and Windows 2000. ASPI-Managers for DOS, Windows and Novell NetWare. I₂O ready controller design.
- Controllers equipped with Cluster RAIDYNE® Firmware (GDT76xyRN) include support for Microsoft® Cluster Server® (MSCS) and the Orion® Server from Novell. There is also support for Linux Clustering solutions.

A.2 Copyrights, Patents

Parts of the ICP GDT RN and RS Series controllers are protected under international copyright laws and agreements. No part of the product or the manual, or parts of the manual may be reproduced in any form, physical, electronic, photographic, or otherwise, without the expressed written consent of ICP vortex Computersysteme GmbH. For this product a patent is registered at the Deutsches Patentamt in Munich with the official reference no. 4121974.

All special names and trademarks of manufacturers quoted in this manual are protected by copyright.

ICP - Intelligent Computer Peripherals ® and **RAIDYNE** ®, are registered trademarks of ICP vortex Computersysteme GmbH.

Europe: ICP vortex Computersysteme GmbH ■ Konrad-Zuse-Str. 9 ■ 74172 Neckarsulm - Germany ■ Tel.: +49-(0)-7132-9620-0 ■ Fax: +49-(0)-7132-9620-200 ■ E-Mail: support@vortex.de ■ WWW: <http://www.icp-vortex.com>

United States of America: ICP vortex Corporation ■ 4001 E. Broadway, B-20 ■ 85040 Phoenix, Arizona ■ Phone: 602-414-0414 ■ Fax: 602-414-0444 ■ E-Mail: support@icp-vortex.com ■ WWW: <http://www.icp-vortex.com>

ICP vortex is member of the RAID Advisory Board, the PCI Special Interest Group (PCI SIG) and founding member of the I₂O Special Interest Group (I₂O SIG):

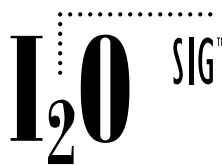

A.3 Software License Agreement

Please read this Software License Agreement before opening the CD/disk packaging and before starting to use the programs. Each loading of a program covered by this license agreement, each transmission within any existing network to another computer, as well as each copy on a mass storage system, regardless of what kind (floppy disk, hard disk, CD, MO, etc.), represents a duplication of the program according to copyright regulations. Duplication is permitted only with the authorization of ICP vortex.

This authorization will be granted only on the condition that the Software License Agreement stated hereafter is observed.

By opening the CD/disk packaging you expressly acknowledge the Software License Agreement of ICP vortex.

1. You are authorized to use the software contained on the enclosed disks, CDROMs and EPROMs/Flash-RAMs on a single computer system only. The restriction to this one computer system also applies if the disk packaging contains a double set of software, for example one set of 3.5" floppy disks and a CDROM. It is further valid if the package contains several versions of software adapted to different operating systems. A multi-utilization of the software is only permitted when a multi-user license has been purchased. The number of further computer systems authorized for usage under a multi-user license is evident from and limited by that license.
2. It is permitted to produce one single copy disk of the software for back-up purposes only. Furthermore, it is permitted to copy the software onto the hard disk of one single computer. It is not permitted to duplicate the contents of the EPROMs and/or Flash-RAMs on the ICP Controller.
3. The permanent conferring (by sale or donation) of the software is permitted. The new proprietor must be registered with ICP vortex and must assume all rights and obligations resulting from this Software license agreement. Each and any other kind of transfer, especially leasing, is not permitted. Copies made by the first user for security reasons must be destroyed upon transfer.
4. It is not allowed to change the software in its functions or its appearance (especially trade mark, firm name and copyright reference) or to edit it in any other way. Neither is it permitted to de-compile or disassemble the software.
5. The enclosed software has been carefully copied on floppy disks and/or CDROM(s). However, if the floppy disks and/or CDROM(s) should prove to be faulty, ICP vortex will exchange them within 4 weeks from the date of purchase.
6. ICP vortex makes no warranties, express or implied, including without limitation the implied warranties of merchantability, functionality and fitness for a particular purpose. In particular, ICP vortex is not liable to you for any consequential, incidental or indirect damage arising out of the use of this product.
7. This agreement is subject to the laws of the Federal Republic of Germany. Place of jurisdiction for both parties is the domicile of ICP vortex Computersysteme GmbH.

A.4 General Information

The ICP Controller should be installed by an authorized ICP vortex distributor. Precondition for the safe installation is an anti-static work place (earthed mat on the table with wrist bands connected to an earth). ICP vortex does not take any responsibility for damage arising out of improper installation. This manual contains all the information available at the time it was written. Errors and/or incomplete information are possible. We are grateful for any ideas or suggestions for improvement. Additional information may be found in the information file "**README.TXT**" on the enclosed ICP CDROM. Besides up-to-date information, this file also contains a list of all programs on the CDROM.

The contents of the file README.TXT must be read before the ICP Controller is used for the first time. Output is possible on printer or screen.

This **User's Manual** explains the installation and the operation of the ICP Controller. For information on the use of the computer system and its operating system, please refer to the corresponding system manuals.

A.4.1 Unpacking the ICP Controller

Open the show box and take out the ICP Controller (leaving it in its anti-static bag), the CDROM and this manual.

WARNING: Never take the GDT PCB (Printed Circuit Board) out of the anti-static bag unless this is done at an anti-static work place, and the person handling the ICP Controller is secured with wrist bands against electrostatic charge. If these instructions are not observed, the CMOS components on the ICP Controller may be damaged or destroyed.

Store the show box in a safe and dry place.

A.4.2 Delivery Contents

The following items are delivered with the ICP Controller:

1. ICP Controller in a sealed anti-static bag without RAM (minimum 16MB required)
2. Sealed CDROM with driver and installation software.
3. This User's Manual.

A.4.3 Contents of the ICP CDROM

A list of the files and programs delivered with the ICP Controller can be found in the file **README.TXT** on the enclosed CDROM. The contents of this file can be viewed on screen or output on your printer. Besides these files and programs there are also disk images of all ICP driver floppy disks, which can be used with a special image-writing program to create a full set of disks. This can be helpful if you require for example a BTLD floppy disk for the installation of the ICP Controller under SCO UNIX.

A.4.4 Before You Start

In order to avoid damage caused by improper or faulty usage or handling, **we strongly recommend** reading this manual carefully before installation or first operation.

A.5 Product Description

A.5.1 Intel i960RS or i960RN I/O Processor

The i960RS/RN I/O processors are members of a new RISC CPU generation which was specifically designed for I/O applications. This pure 64 Bit CPU on an ICP Controller can reach a performance of **+100 MIPS** and supervises all tasks of the SCSI devices, the RAID controlling and the communication with the PCI computer. In doing so, it significantly offloads the PCI computer, leaving it free to perform its original tasks.

A.5.2 64 Bit Architecture

To meet the demands on a high performance controller, the bus architecture of the ICP Controller has a **64 Bit** layout.

- 64 Bit control processor (i960Rx I/O Processor)
- 64 Bit bus-interface (PCI) for RN Series and 32 Bit for RS Series
- 64 Bit memory controller (with ECC)

A.5.3 Cache RAM - Expandable to 128MB

The cache RAM of an ICP Controller consists of one standard non-buffered PC100 DIMM (as used in most motherboards). The cache size is flexible as different memory sizes can be obtained by using different modules. Thus, the memory can be expanded to 16MB, 32MB, 64MB or 128MB.

The user can install both, normal and ECC DIMMs. An intelligent multi-level cache algorithm ensures that a high hit rate (cache hit) is achieved. Both, look-ahead and special delayed-write cache functions are implemented. With the ICP configuration and monitoring utilities ICPCON and ICP RAID Navigator, the user can adjust various cache parameters.

A.5.4 Compatibility - PCI

The ICP Controllers have been developed in accordance with the 2.2 PCI-Bus specifications. They perform full bus-master DMA and can be operated in both, 32 Bit and 64 Bit PCI bus mastering slots. The transfer rates are 132MB/sec in a 32 Bit PCI slot and 264MB/sec in a 64 Bit slot (for RN Series ICP Controllers). RN Series ICP Controllers can also be operated in 32 Bit slots.

A.5.5 Up to 6 Ultra 160 SCSI Channel

The ICP Controllers are available with up to six Ultra 160 SCSI channels. The RN Series Wide/Ultra2 SCSI Controllers have one additional Wide/Ultra SCSI channel for legacy SCSI devices. Per Channel up to **15 devices** can be connected. The maximum data transfer rate is **80MB/sec on the Wide/Ultra2 SCSI channel, 160MB/sec on the Ultra 160 SCSI and 40MB/sec on the Wide/Ultra SCSI channel.**

The Wide/Ultra2 SCSI channels have a multimode termination and allow cable lengths up to 12 meters. The Wide/Ultra SCSI channel is equipped with an active termination. All termination settings are software-switchable.

A.5.6 ICP Controller Firmware, BIOS and ICP RAID Console

The firmware, the BIOS of the ICP Controller and the configuration and monitoring program ICPCON are stored in a Flash-RAM on the ICP Controller PCB. The firmware is designed for parallel processing and it controls all resources of the ICP Controller. This means that the entire administration of SCSI devices and RAID is exclusively carried out by the ICP Con-

troller. Thus, the host is significantly offloaded. In addition, this hardware-implemented solution guarantees the highest achievable security. The controller-BIOS provides a complete PCI compatible INT13 interface and expands the respective functions of the system BIOS. It also ensures that operating systems using the INT13 (i.e. MS-DOS, OS/2) can be booted directly from a SCSI device / RAID Array Drive connected to the ICP Controller. According to the various product expansion levels of the RS/RN Series, two different firmware levels are available. Installed upon delivery are the

Standard Firmware (RAID 0, 1)	in	GDT7118RN, GDT7128RN GDT6118RS, GDT6128RS GDT7123RN
RAIDYNE® Firmware (RAID 0, 1, 4, 5, 10)	in	GDT7518RN, GDT7528RN, GDT7538RN, GDT6518RS, GDT6528RS, GDT6538RS GDT7523RN, GDT7543RN, GDT7563RN
Cluster RAIDYNE® Firmware (RAID 0, 1, 4, 5, 10)	in	GDT7618RN, GDT7628RN, GDT7638RN, GDT7623RN, GD7643RN GDT7663RN

A controller originally equipped with the Standard Firmware can be easily upgraded by the user with the RAIDYNE® Firmware. The Standard Firmware offers the RAID Levels 0 and 1. As controllers have the RAIDYNE-Firmware, RAID Levels 0, 1, 4, 5, 10 and security features such as *Hot Fix* or *Hot Plug* become available. RAIDYNE® is also capable of performing an online capacity expansion of an existing array by adding one or more new hard disks. During expansion the array is fully operational. Another feature of RAIDYNE® is the online RAID Level Migration of an existing array, e.g., from RAID 0 to RAID 5. GDT76x8RN controllers are equipped with the "Cluster RAIDYNE®" firmware, which not only includes all necessary functions for supporting the Microsoft® Cluster Server® (MSCS), and Novell Orion®, but also Linux Clustering solutions. There is an optional "Cluster Module" to upgrade GDT75xyRNs to GDT76x8RNs.

A.5.7 Configuration and Monitoring utilities "ICP RAID Console" and "ICP RAID Navigator" Program ICPCON

These two configuration and monitoring programs are very flexible software tools that offer many different configuration, diagnosis and monitoring functions during full-operation conditions. ICPCON has a character-oriented user surface and is ideally suitable for NetWare and all types of UNIXes including Linux. ICPCON is also available at system boot level as a rom resident tool (press <CTRL><G>). ICP RAID Navigator has a Windows NT compliant graphical user interface (GUI) and can be operated under Windows 95/98/NT/2000. Both tools can be used on the fileserver, or remotely from an authorized workstation. The main functions are:

- Configuration of Disk Arrays (also with EXPRESS function)
- Monitoring the disk subsystem performance (KB/sec and I/Os per sec.)
- Online configuration of the cache memory
- Online check of the parity information of RAID 4 and RAID 5 Array Drives
- Online capacity expansion and RAID level migration of existing Array Drives
- Hot Plug and Hot Fix
- Remote Operation (IPX, NetBIOS, TCP/IP), Messaging

ICP Firmware / ICP BIOS / ICP Tools

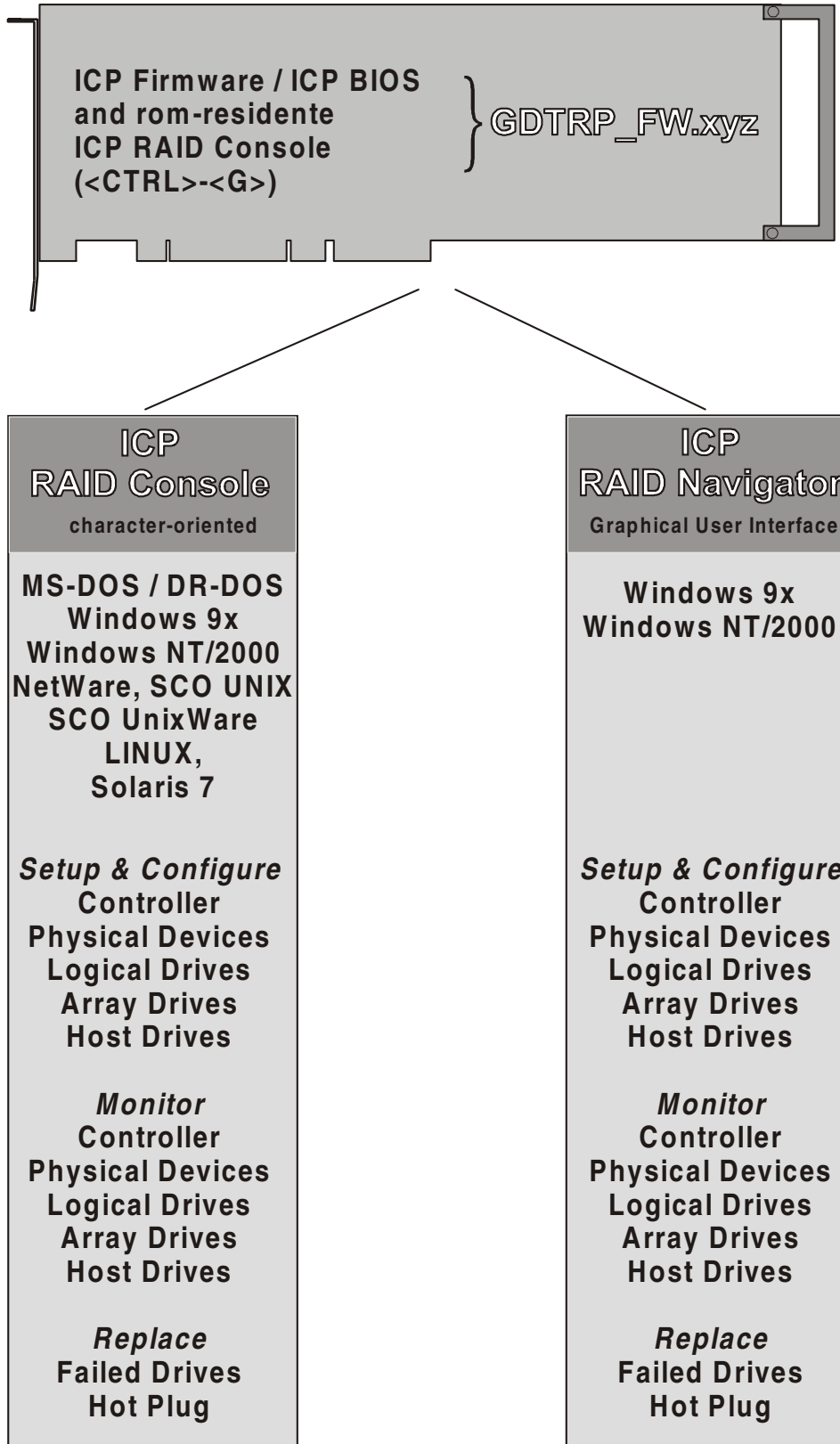

A.5.8 Operating System Driver Software

Drivers for the following operating systems are available:

Operating System	Driver included with the Controller Package
MS-DOS 3.3 to 6.x	Yes
Novell NetWare 3.x, 4.x, 5.x	Yes
SCO UNIX System V/386 3.2v5.x	Yes
SCO UnixWare 2.x and 7	Yes
Windows NT , 3.5x, 4.x	Yes
Windows 2000	Yes
Windows 95/98	Yes
Solaris 7	Yes
Linux	Yes

The following table shows how various devices are integrated by different operating systems. Please refer to the corresponding chapters of this User's manual and the operating system documentation for detailed installation information.

	Hard Disk	Remov. HDD	CDROM	Streamer	WORM	MOD
MS-DOS	GDT	ASPI or GDT	ASPI	ASPI	ASPI	ASPI/GDT
NetWare	GDT	GDT	ASPI	ASPI	ASPI	ASPI/GDT
UNIX/LINUX	GDT	GDT	UNIX	UNIX	UNIX	UNIX/GDT
Win. NT	GDT	Win.NT or GDT	Win.NT	Win.NT	Win.NT	Win.NT

GDT: Configurable with ICPCON (some MODs are recognized as a hard disk (see your MOD manual). In this case, they too can be configured with ICPCON). **ASPI:** Integration by means of an ASPI interface. **UNIX/LINUX, Win.NT:** Supported by the operating system.

A.5.9 ICP Controller Board Layout

The ICP Controller PCB (Printed Circuit Board) has several jumpers. In the following illustrations, all jumpers are shown in their factory setting. Under normal circumstances there is no need to change these settings.

GDT7118RN, GDT7518RN and GDT7618RN Overall View

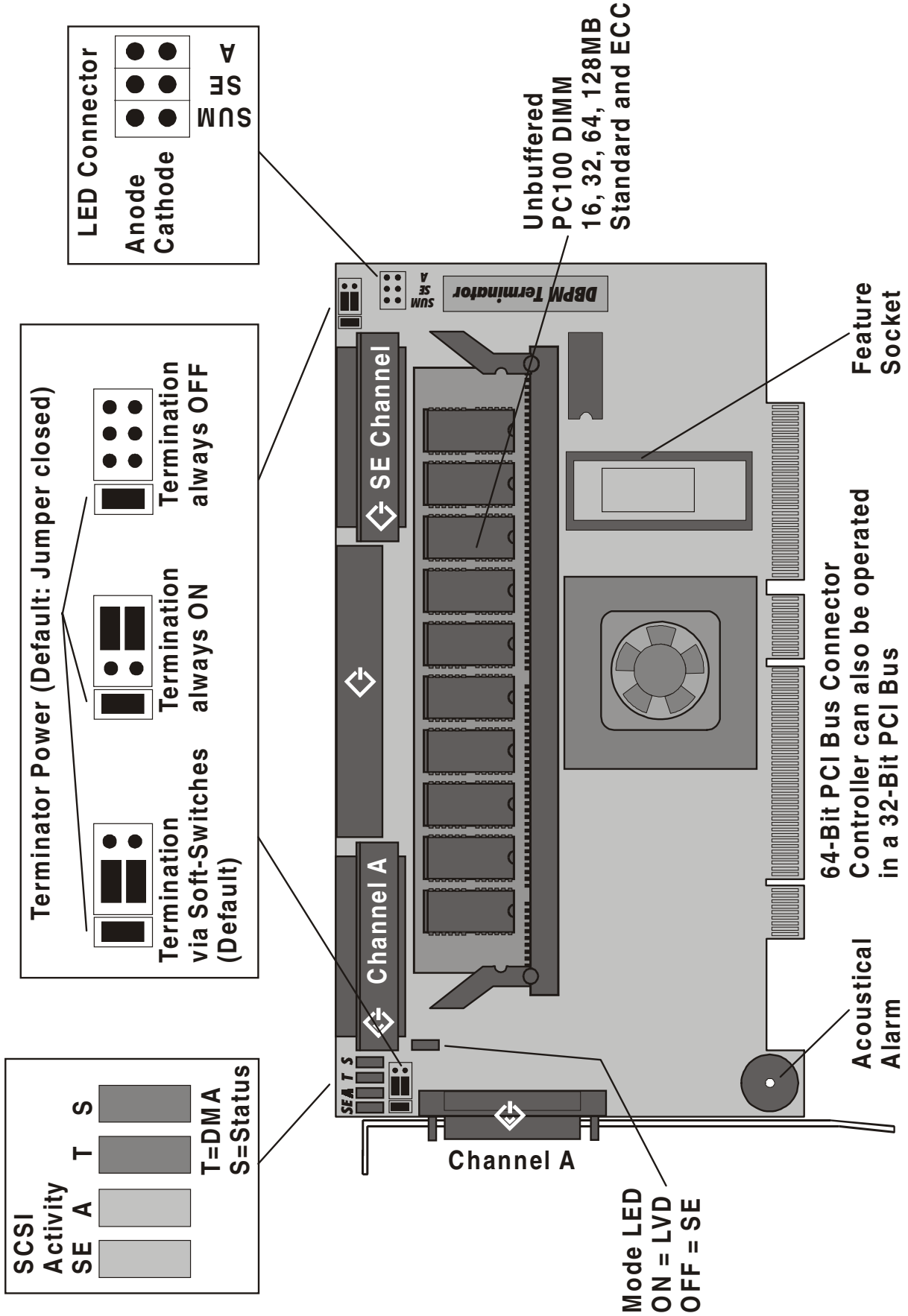

GDT7128RN, GDT7528RN and GDT7628RN Overall View

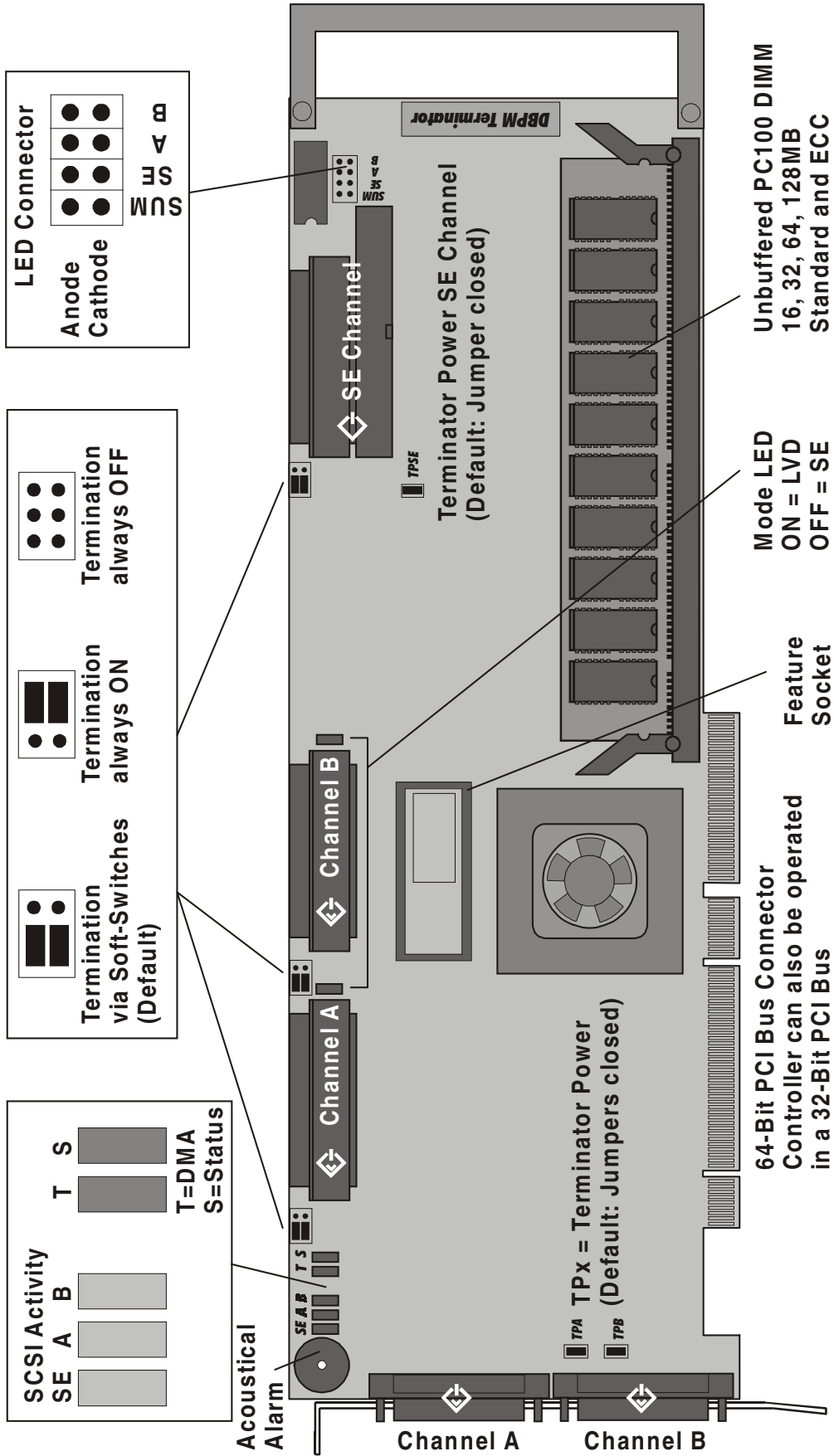

GDT7538RN and GDT7638RN Overall View

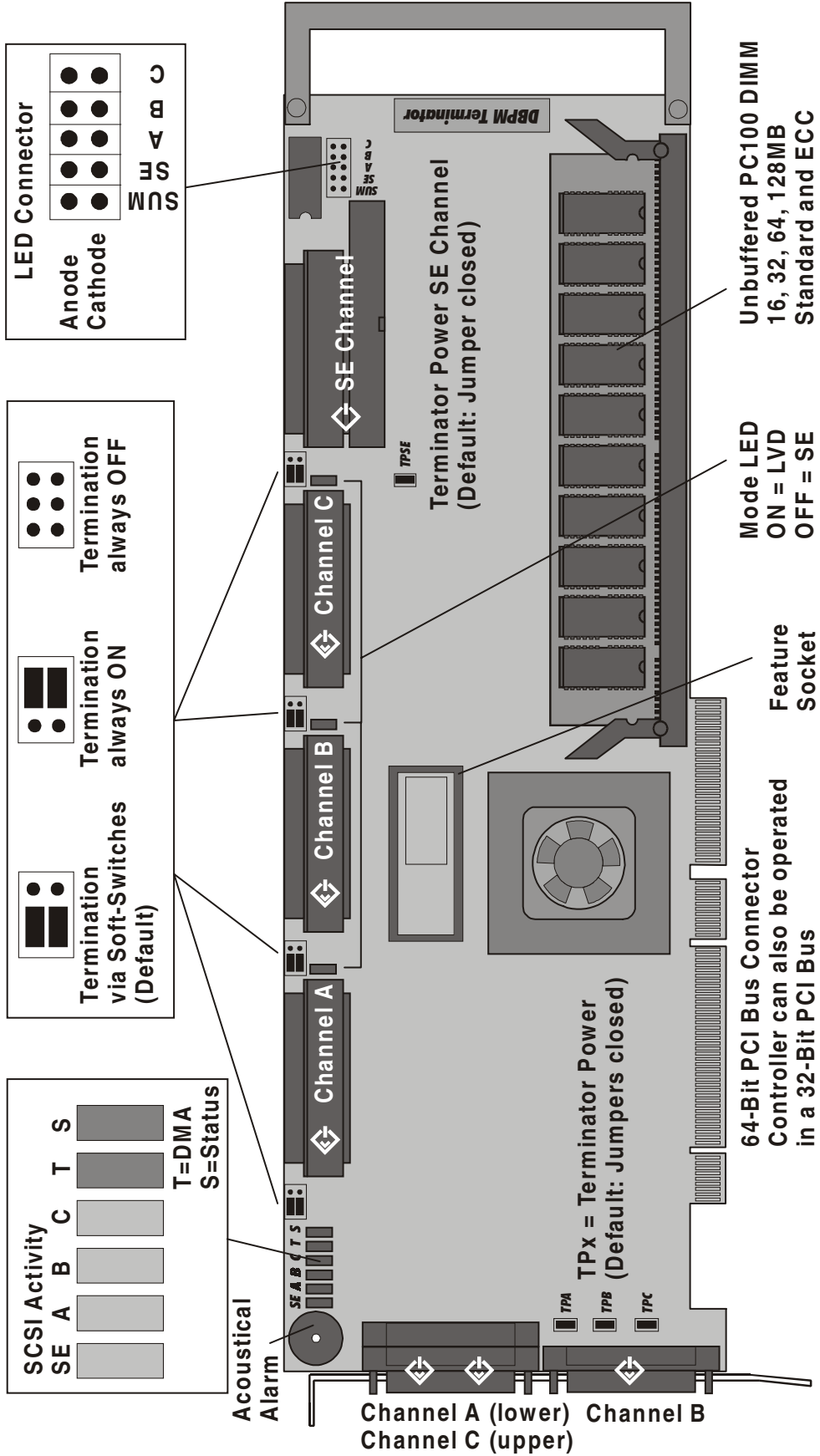

GDT6118RS and GDT6518RS Overall View

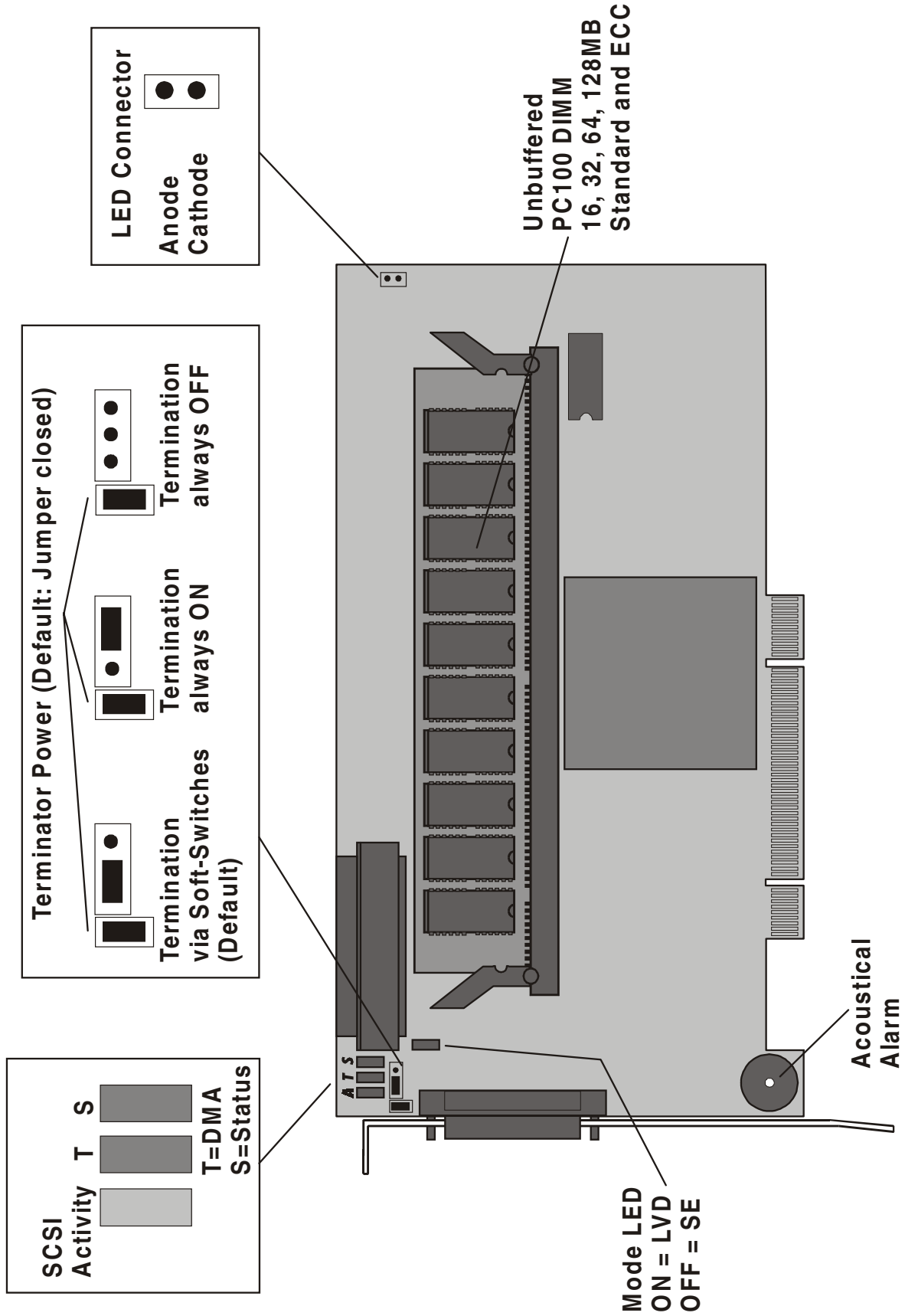

GDT6128RS and GDT6528RS Overall View

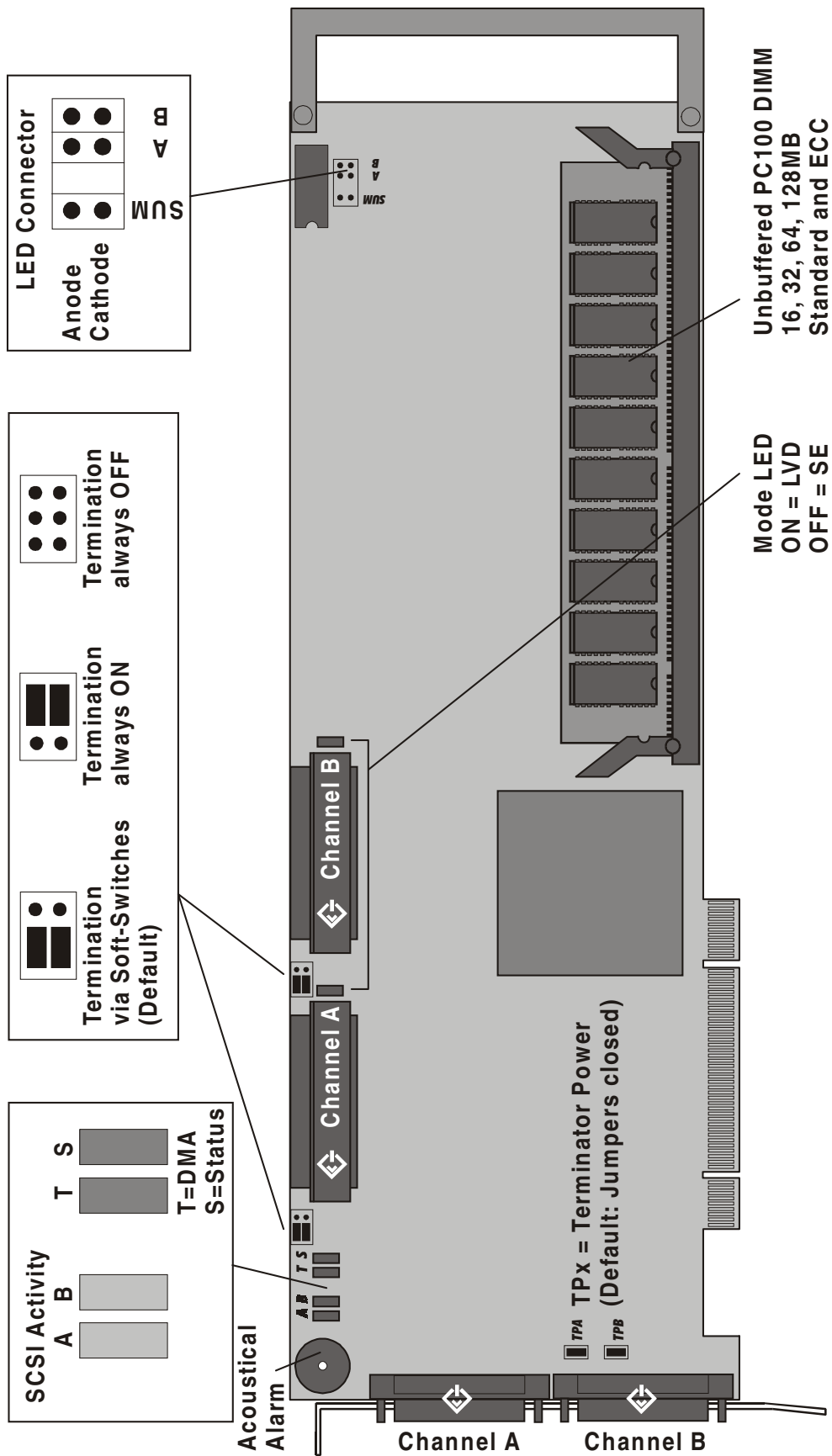

GDT6538RS Overall View

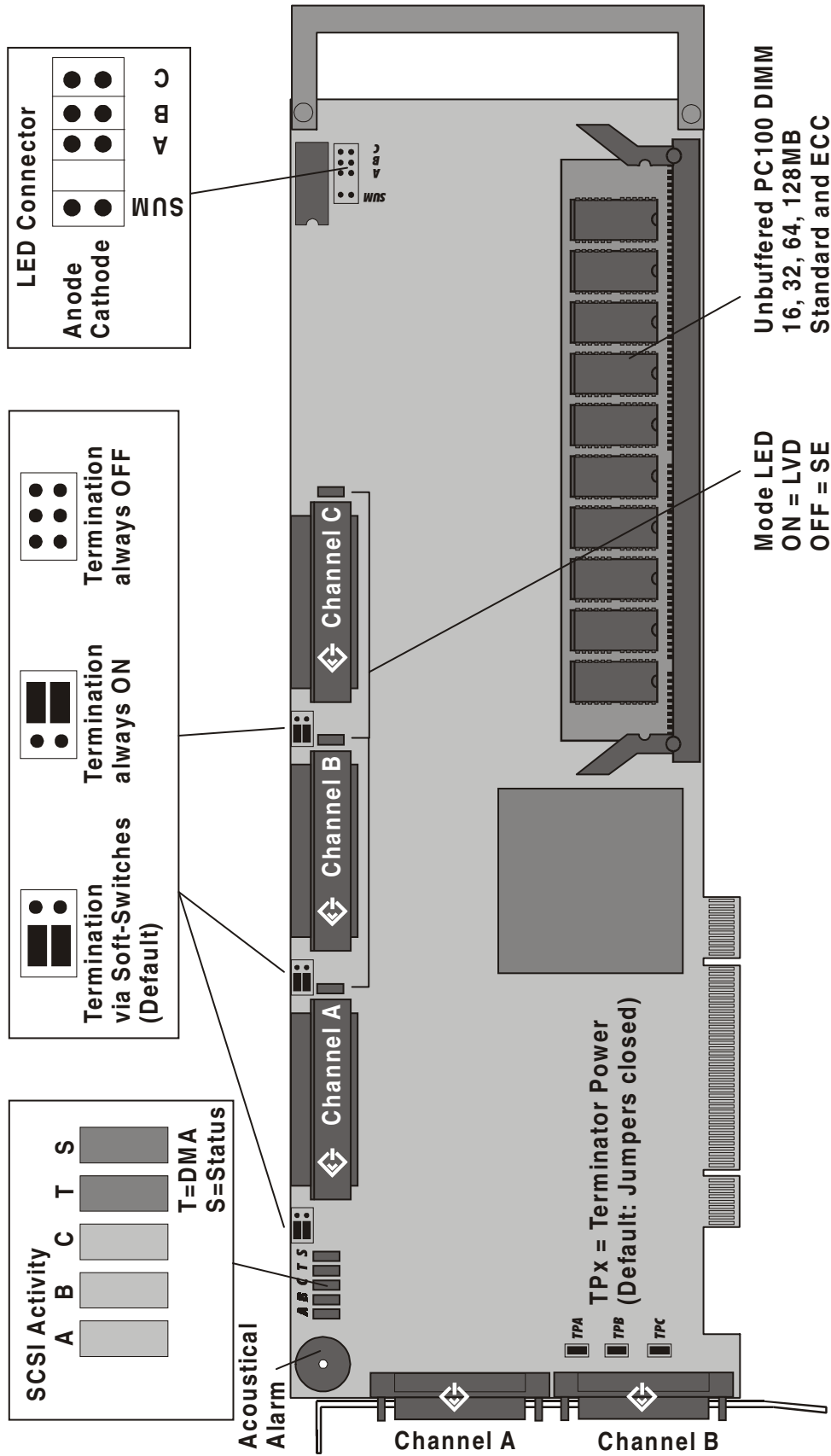

GDT7123RN, GDT7523RN and GDT7623RN Overall View

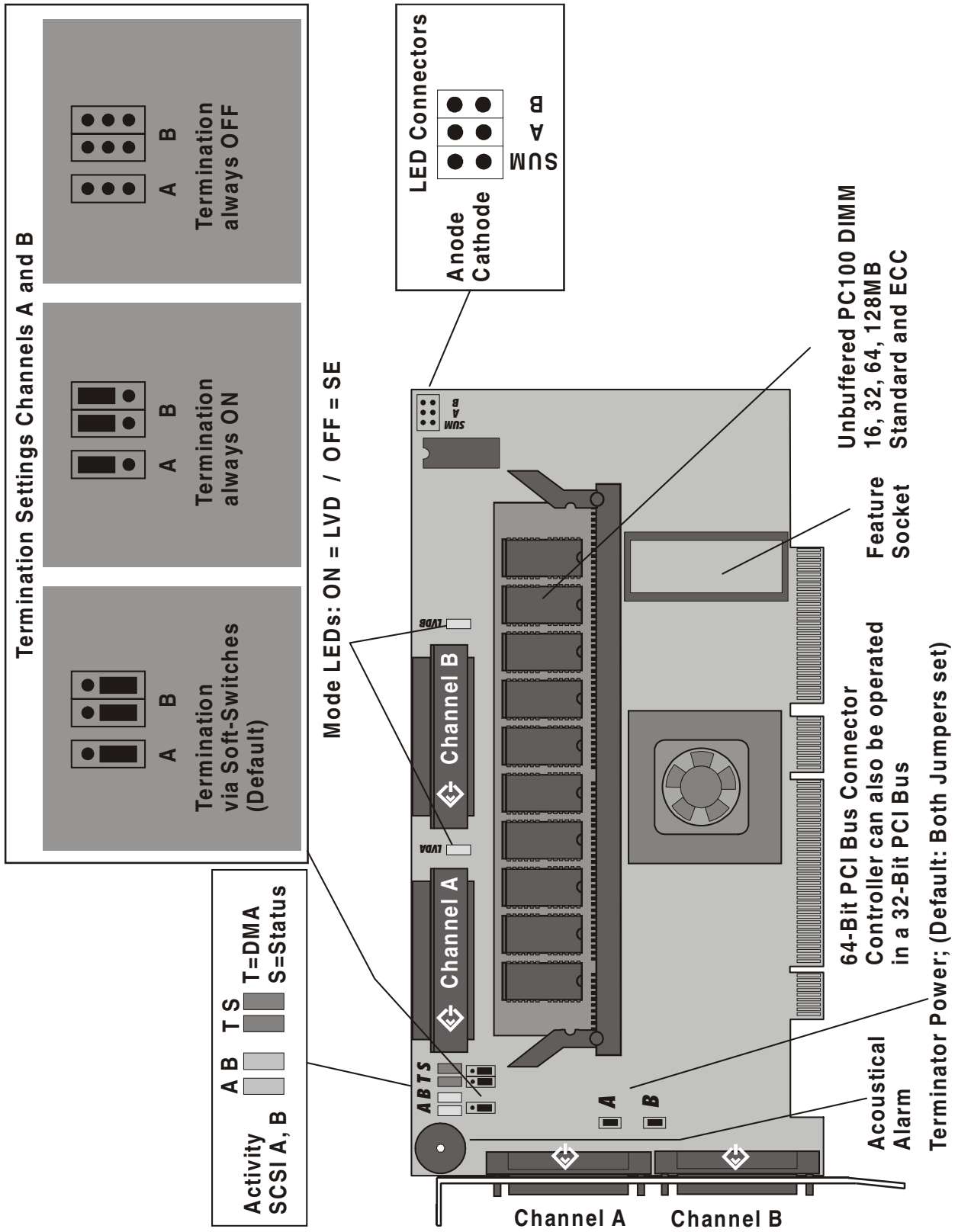

GDT7543RN and GDT7643RN Overall View

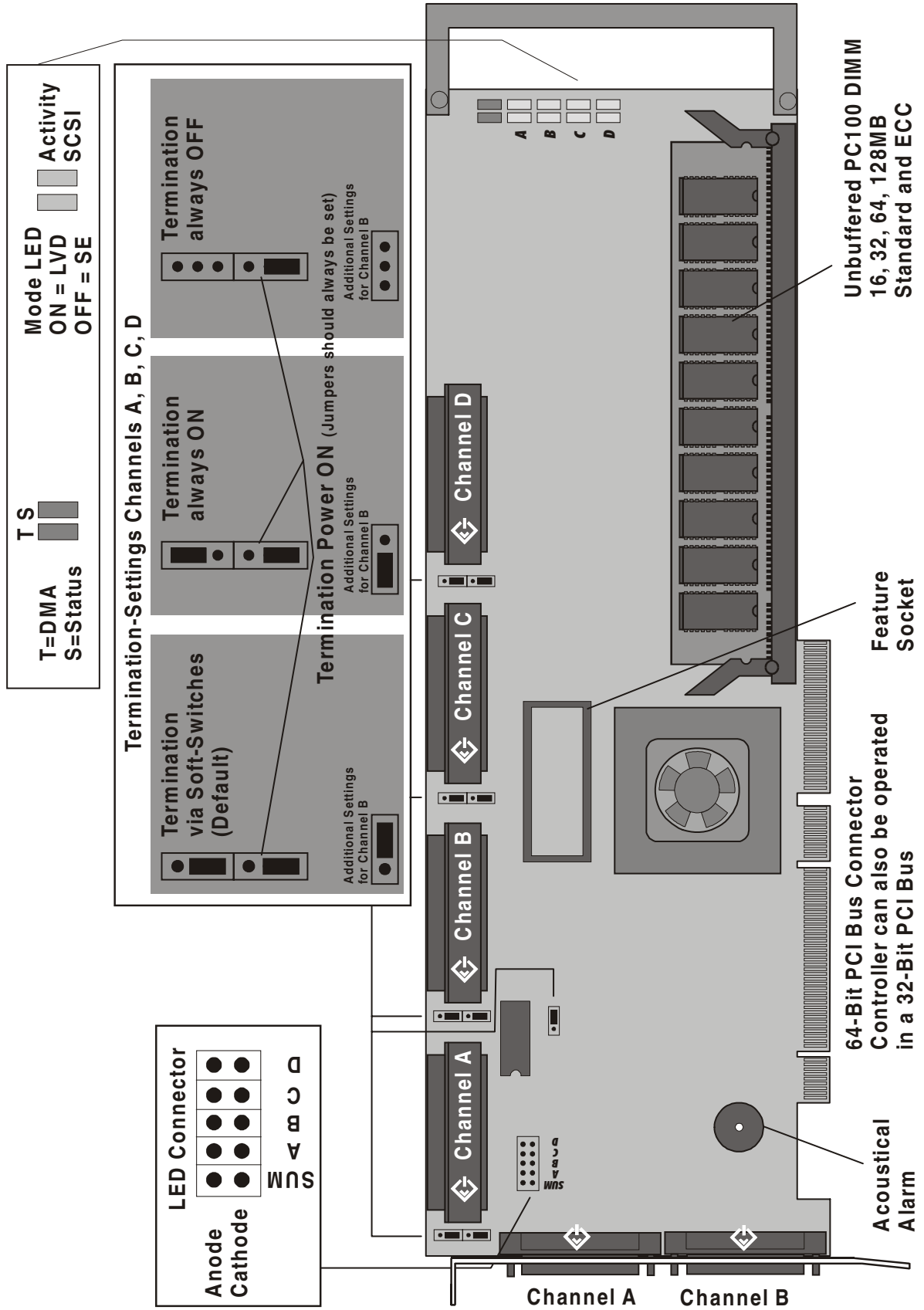

GDT7563RN and GDT7663RN Overall View

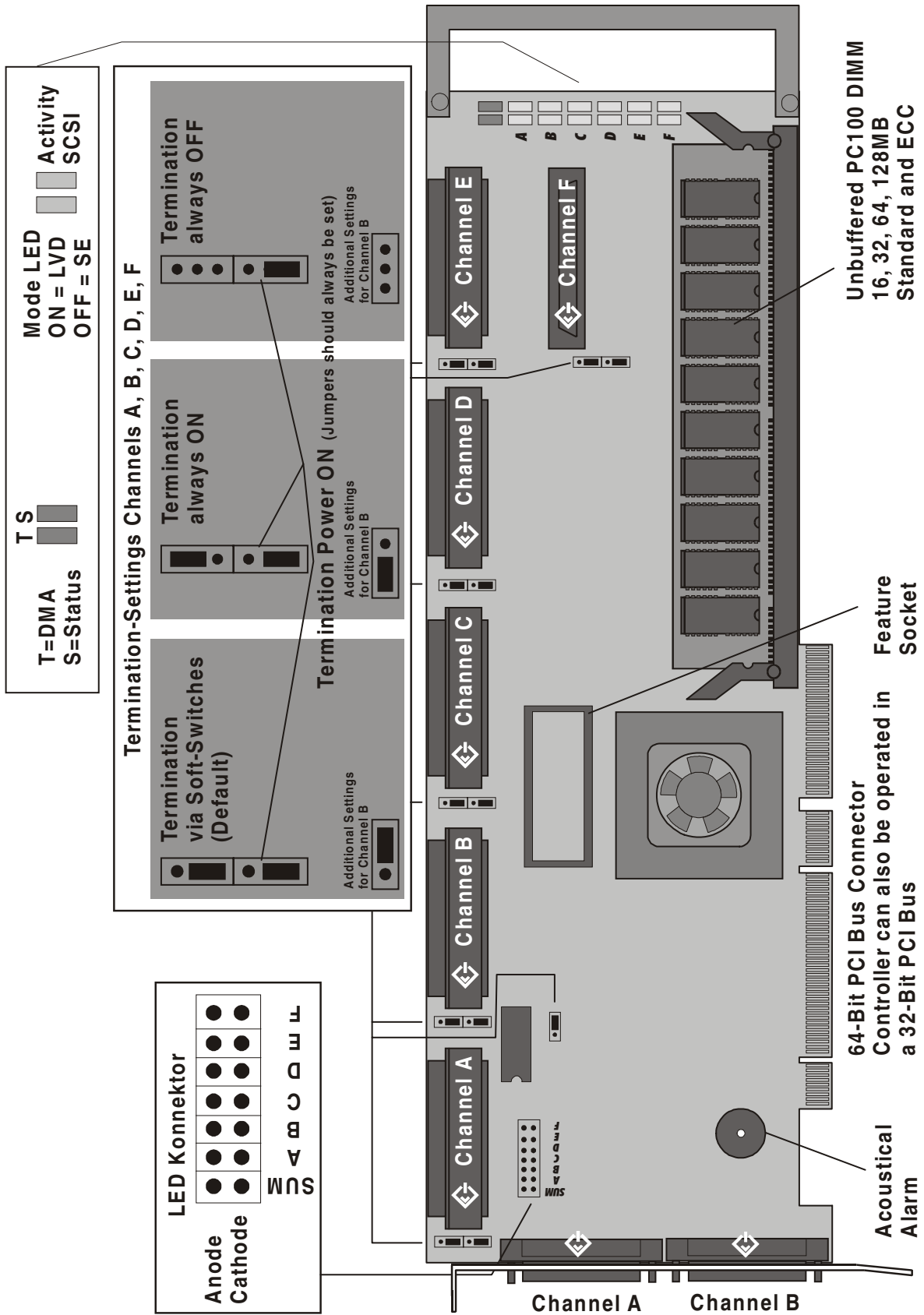

Chapter B

Hardware

Installation

B. Hardware Installation

B.1 Before Installation

The ICP Controller is designed for minimum power consumption and maximum operational security. It therefore contains delicate electrical components (CMOS). In order to avoid damages caused by electrostatic charges, the following warning must be observed during installation:

Never take the ICP Controller out of the antistatic bag unless this is done at an anti-static work place and the person handling the ICP Controller is secured against electrostatic charge through wrist bands. If these instructions are not observed, the user risks damage or destruction of the CMOS components of the ICP Controller !

B.2 Tools

Before installing, please switch off the complete computer system and remove all cables including the power cable. Open the case of the host computer with an appropriate screwdriver (usually a medium sized Philips screwdriver).

B.3 Installing the PC100 DIMM Module

It is not possible to operate the ICP Controller without PC100 DIMM (Dual Inline Memory Module). The ICP Controller is delivered without PC100 DIMM (OMB). The ICP Controller must be operated with one non-buffered PC100 DIMM or one non-buffered ECC PC100 DIMM . The PC100 DIMM capacity can be 16MB, 32MB; 64MB or 128MB. The ICP Controller can not be operated with buffered DIMMs.

If the ICP Controller is not yet equipped with cache RAM, or if another PC100 DIMM is to be installed, we recommend adding it before you install the ICP Controller in your computer system. As mentioned before, the ICP Controller can be run with four different cache RAM

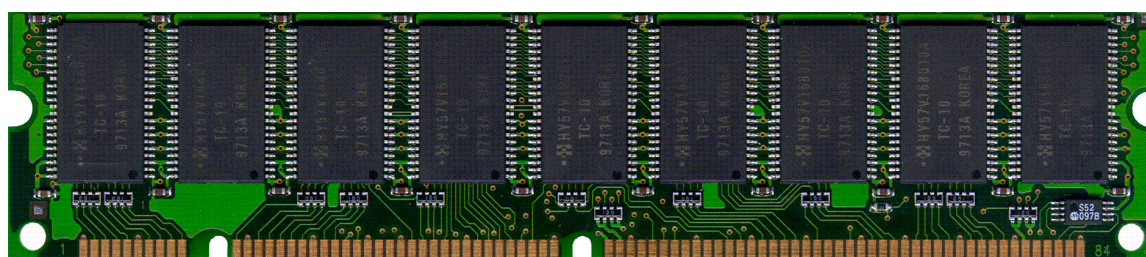

sizes. The minimum cache RAM size is 16MB. The maximum cache RAM size is 128MB. The ICP Controller provides one socket for a PC100 DIMM. The PC100 DIMM is correctly plugged into the DIMM socket of the ICP Controller if it is engaged correctly into the socket's retaining clamps and if all contacts of the PC100 DIMM are equally contacting the corresponding pins of the socket. To release an installed PC100 DIMM, carefully press the retaining clamps to the side.

Each time you switch on the computer system, the ICP Controller automatically recognizes how much cache RAM is available and configures itself accordingly.

B.4 SCSI - Basics

Whoever has been involved with the subject of SCSI will have noticed that the "Small Computer System Interface" is an extremely interesting technology, which has become widely accepted in comparison to other interface models and has constantly adapted to the needs of customers. This builds up confidence and (investment) security. Last but not least, SCSI has remained the de facto I/O interface for smaller to mid-sized mass storage systems. The innovating factors are and were; downward compatibility (connector, protocols), the bandwidth (10MB/sec., 20MB/sec., 40MB/sec., 80MB/sec., 160MB/sec.) and the cable length (3 Meters to 12 Meters). The following table gives you an overview on the various development steps:

	"Ultra SCSI" (FAST-20)		"Ultra2 SCSI" (FAST-40)		"Ultra160 SCSI" (FAST-80)
	8 Bit Narrow	16 Bit Wide	8 Bit Narrow	16 Bit Wide	16 Bit Wide
Max. Transfer-rate [MB/sec.]	20	40	40	80	160
Max. Number Devices	7	7 (15)	7	15	15
Bus-Type	SE	SE	LVDS	LVDS	LVDS
Cable Length [Meter]	1.5	1.5	12	12	12
Connector	50 pin	68 pin	50 pin	68 pin	68 pin

We differentiate between Single Ended (SE) and differential buses .
(Note: The above listed table does not show differential Bus-Types for Fast-SCSI.)

Single ended buses have the disadvantage that they are highly susceptible to distortion and therefore have to be shorter than differential buses. In SE environments, logical information is represented in terms of voltage levels on a wire. Therefore, small distortions can change the voltage level significantly which results in transmission errors. The current levels on the SE bus are reasonably higher than on a differential bus.

If the differential data transfer method is used, two wires with separate voltage levels are used per signal. Only the voltage difference between the wires represents the logical information. Because distortion has the same effect on both wires, it is automatically deleted during calculation of the difference. In this way, much longer cables with higher transfer rates are possible than in SE systems.

Differential SCSI has existed for a long time. However, it has always played a somewhat exotic role as the SCSI Controller and also the disks had to be differential and could only be operated in this way. Single Ended devices could and were not allowed to be used.

The Wide/Ultra2 SCSI and Ultra 160 SCSI ICP Controllers are able to work with one and the same connector in SE-Mode as well as in differential mode without the need for additional hardware. However, a SCSI Bus can be operated either in SE or differential mode, but not both at the same time. The SCSI Spec requires that SCSI devices „running“ in differential mode automatically switch to SE mode if they recognise that a pure SE device is connected to the cable.

The so-called LVDS - Low Voltage Differential Signaling - was chosen as the differential transfer technology for Ultra2 SCSI and Ultra 160 SCSI. LVDS is treated completely independently from SCSI and is defined via an ANSI and IEEE Norm. At present LVDS is also used for transferring video data etc.

In LVDS-Mode, an SE signal wire and its associated SE ground wire (GND) build a differential pair. Therefore, please take care when choosing an external round cable. It has to be

explicitly designed for LVDS. Very often all GND wires are put together in the connector. These kinds of cables must not be used for LVDS.

- 80MB/sec. or 160MB/sec synchronous data transfer rates
- Up to 12 Meters cable length

It is very important for you to observe the information and notes given in this section of the User's Manual because it helps to ensure that the SCSI devices that are used in connection with the ICP Controllers are operated in a successful, long-lasting and trouble-free manner. In many cases, this information is not only applicable to ICP Controllers, but in general to all those SCSI systems which, like the ICP Controllers, use Wide/Ultra2 or Ultra 160 technology. According to its definition, the SCSI bus provides access to several participants that are physically connected through an appropriate SCSI bus cable. To achieve a sufficiently good signal quality, it is not only recommended to use very good cables and connectors, but also to terminate both ends of the cable properly. For an unambiguous identification on the bus, all participants have a unique number – the so-called SCSI-ID. Further details on these topics can be found on the following pages.

Please note that **98% of all SCSI-related problems are caused by bad SCSI cables, wrong SCSI bus termination and duplicate SCSI-IDs.**

B.4.1 SCSI Cables

The quality and overall length of the cable, as well as the number and quality of the SCSI connectors is very important for both internal and external SCSI cables. Generally, internal SCSI cables are 50 or 68 conductor flat ribbon cables. To connect external SCSI devices, round and shielded cables with appropriate connectors are typically used. External round cables should have a SCSI-compliant placement of the inside conductors and should be approved for LVDS operation. Besides the cables, the right connectors for a cable are also very important. It is highly recommend to use highest quality connectors, only.

The following table shows the maximum cable lengths allowed for a given transfer rate. Based on many years of SCSI experience, the lengths we recommend are in some cases shorter than theoretically possible. The information in the table refers to one SCSI channel and represent the overall length of the cable, including internal and external parts.

SCSI Bus Width	SCSI Mode	Bus-Type	Synchronous Data Transfer Rate	Number of devices	Max. Cable Length
8 Bit, narrow	Fast	SE	10 MB/sec.	7	2.0 meters
8 Bit, narrow	Fast-20, Ultra	SE	20 MB/sec.	4	1.5 meters
8 Bit, narrow	Fast-40, Ultra2	LVDS	40 MB/sec.	7	12 meters
16 Bit, wide	Fast	SE	20 MB/sec.	15	2.0 meters
16 Bit, wide	Fast-20, Ultra	SE	40 MB/sec.	4	1.5 meters
16 Bit, wide	Fast-40, Ultra2	LVDS	80 MB/sec.	15	12 meters
16 Bit, wide	Fast-80, Ultra160	LVDS	160 MB/sec.	15	12 meters

In addition to specifications mentioned above, the following should be kept in mind when selecting and installing SCSI cables:

- Always install SCSI cables that are as short as possible. The lengths in the table above are absolute maximum lengths. (Total length of internal and external cables per channel).

- Avoid using SCSI cables with more connectors than actually needed. Never select a SCSI mode or operate a SCSI device with a cable that is not appropriate for this mode.
- The minimum distance between two connectors of a SCSI cable is 20 cm.
- Avoid cable stubs. If this is not possible, keep the stub length below 10 cm. "Star cabling" are not allowed.
- Keep the number of transitions from flat to round cables and vice versa as small as possible. It is usually best is to use flat or round cables, only.
- Check these points when routing SCSI cables:
 - Avoid kinks in the SCSI cable
 - Do not roll the SCSI cable up on itself
 - Avoid routing the cable next to other cables
 - Avoid routing the cable in the vicinity of noise sources such as power supplies
 - Avoid routing the cable over sharp edges and in areas where it could get caught up
 - Avoid routing/sticking the cable directly onto metal surfaces
- When using internal Wide/Ultra2 SCSI cables make sure that the cable has in both modes, SE and LVD, the correct impedance. The "Spectra Strip" cable material from Amphenol fulfills the required specification (color coding: first pair blue/white all other pairs orange/white) and complies with the ANSI T10/1142 D document. ICP vortex offers a finished cable assembly which is based on this raw material (Order No.: 8839). The cable has twisted cable pairs.
For external Wide/Ultra2 SCSI round cables the same rules and specifications apply. ICP vortex offers here two cables: Order No.: 8844 for the 3 meters round cable and Order No.: 8877 for the 1 meter round cable).

When making home-made SCSI cables, make sure that the insulation displacement connectors are properly aligned and firmly pressed into the flat ribbon cable. Otherwise, the whole cable might turn out to be a big short-circuit. Furthermore, check carefully that PIN 1 of the cable connects to PIN 1 of the connectors. A simple short-circuit and continuity test before running the devices helps you to save time and money.

The same warnings as for home-made cables apply when you buy non-brand cables. If you plan to run Fast-20 (Ultra) or Fast-40/80 (Ultra2 or Ultra 160) devices, you should explicitly ask your dealer if these cables are appropriate for the desired mode. (Note: The ICP product range also includes some high quality SCSI accessories. Please see section B.4.4 of this User's Manual or check our Website: <http://www.icp-vortex.com>, for further details).

Example for a SCSI Flat Ribbon Cable for 8 Bit SCSI Devices (narrow)

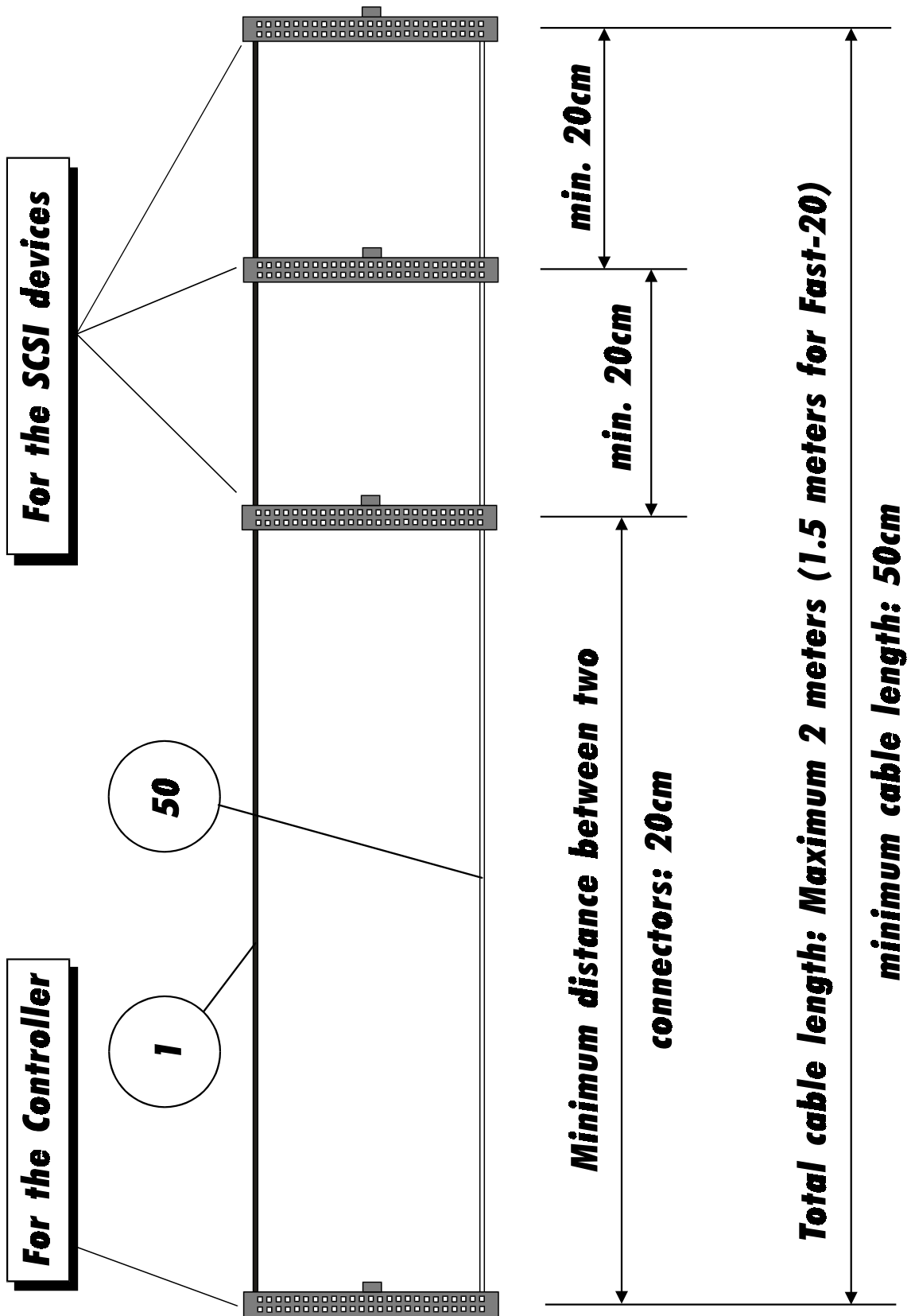

Example for a SCSI Flat Ribbon Cable for 16 Bit SCSI Devices (wide)

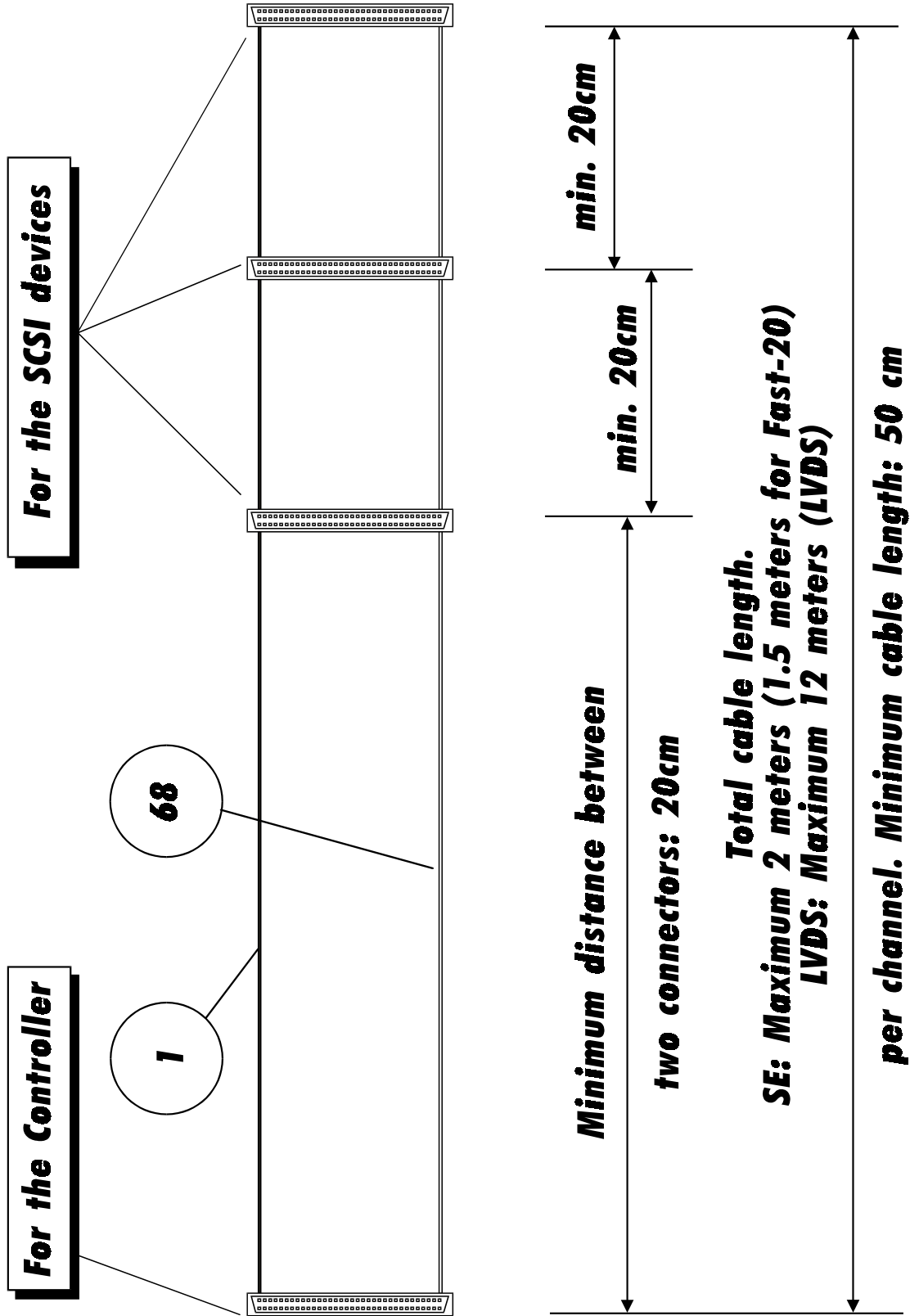

Example for a Wide/Ultra2 and Ultra 160 Flat Ribbon Cable (1.5 Meters)

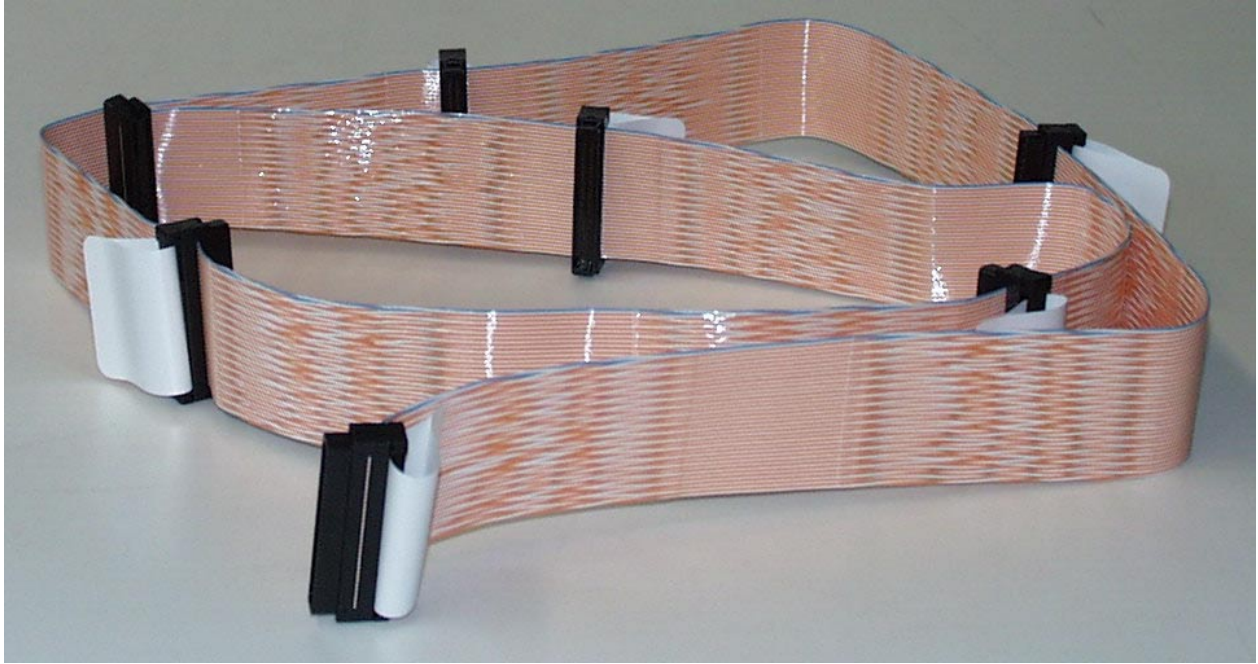

Examples for Wide/Ultra2 and Ultra 160 Round Cables (1 Meters and 3 Meters)



B.4.2 SCSI Termination

In order to ensure a flawless and interference-free signal transmission on the SCSI bus and to minimize the detrimental effects of external noise generators, both ends of the SCSI cable have to be terminated. The SCSI specification prescribes different termination methods for SE and LVDS SCSI bus systems.

There are two alternative termination modes for Single-Ended SCSI bus systems: The passive termination and the active termination, also known as Alternative-2 termination. The passive termination consists of a 220 Ohm pull-up and a 330 Ohm pull-down resistor for each signal. Today, the passive termination is mostly used in systems with synchronous data transfer rates not exceeding 5 MB/sec, which is rather slow. The active termination circuit consists of a 110 Ohm precision-resistor per signal and a common 2.85 Volt voltage regulator. Thus, all signals are actively pulled up to a certain level. The active termination provides much better signal quality and significantly reduced liability to noise.

LVDS SCSI bus systems allow only active LVDS termination. The termination circuitry must automatically recognize, if the bus is operated in SE or LVDS mode and adjust itself accordingly.

All Wide/Ultra2 and Ultra 160 SCSI channels of the ICP Controllers are equipped with a LVDS compliant termination. The additional Wide/Ultra SCSI channel of the Wide/Ultra2 RN Series Controllers uses an active SCSI bus termination. The voltage for the termination circuitry is supplied either by the SCSI device itself, or by the TERMPWR line(s) of the SCSI bus.

The new Wide/Ultra2 and Ultra 160 SCSI devices are delivered without termination. I.e., the SCSI bus cannot be terminated on the last device of the bus, but needs an external termination which allows SE and LVDS operation (see B.4.4 "ICP SCSI Accessories").

- Always use active SCSI bus termination on SE busses.
- Always use multimode termination on SE/LVD busses.
- Do not use SCSI devices with passive SCSI bus termination (e.g., CD-ROMs) for the termination of the SCSI cable.
- Always terminate only the two ends of a SCSI cable.
- The TERMPower (TPx) jumpers on the ICP Controller PCB should always be set.

The onboard termination of the ICP Controller can be changed within the ICP RAID Console or the ICP RAID Navigator. The default setting is "Auto". In this mode the ICP Controller analyses which connectors are occupied and adjusts its termination accordingly. In "Off" mode the termination of the ICP Controller is always off. In "On" mode the termination is always on.

In addition to these "soft-switches" the onboard termination can be also set by jumpers on the ICP Controller PCB.

B.4.3 SCSI ID

All participants on the SCSI bus must have a unique identification number, that is, each number can only be used once on a given cable. Each SCSI device is uniquely addressed through its SCSI ID.

- All participants of a SCSI bus must have a different SCSI ID.

- The factory set SCSI ID of the ICP Controller SCSI channel is 7.
- Up to 15 SCSI devices can be connected to the Wide/Ultra2 and Ultra 160 SCSI channels
- Up to 15 SCSI devices can be connected to the Wide/Ultra SCSI channel. In reality this number is limited to max. 7.

If it is intended to operate on this bus also Wide/Ultra2 or Ultra 160 disk drives, you must set the "SE" jumper on each Wide/Ultra2 disk drive. On IBM drives e.g., this jumper is called "SE Mode".

On hard disks, CD-ROMs, tape streamers, etc., the SCSI ID is normally set through jumpers or small DIP switches. The ICP Controllers offer a far more comfortable method: software switches in the ICP RAID Console or ICP RAID Navigator programs allow you to easily set the SCSI ID of an ICP SCSI channel. It is recommended to leave the default ID value at 7 (allowed values 0, 1, 2, 3, 4, 5, 6 and 7). Some operating systems require that the SCSI ID of certain SCSI device (e.g., tape streamer, CD-ROM) is set to a particular value (for more information, please refer to the appropriate chapter in this manual).

B.4.4 ICP SCSI Accessories

Order #	Part Name	Description	Application
8839	Wide/Ultra2 and Ultra 160 Flat Ribbon Cable	150 cm Wide/Ultra2 and Ultra 160 SCSI cable with seven 68 pin HD SCSI connectors (male).	Connection of up to 5 internal Wide/Ultra2 and Ultra 160 SCSI devices per SCSI channel and one SE/LVD terminator (Order No.: 8951). For LVDS operation.
8840	Fast-SCSI Bracket	Bracket with an internal 50 pin header and an external 50 pin HD SCSI connector (female).	Connection of an external Narrow/Ultra SCSI subsystem with an internal Narrow/Ultra channel. Not for LVDS operation.
8841	Wide-SCSI Adapter	16 Bit to 8 Bit SCSI adapter with a 50 pin header and a 68 pin HD SCSI connector (male).	Connection of Wide/Ultra SCSI devices with an 8 Bit 50 pin flat ribbon cable. Not for LVDS operation.
8842	Wide-SCSI Bracket	Bracket with an internal and an external 68 pin HD SCSI connector (female).	Connection of an external Wide/Ultra SCSI subsystem with an internal Wide/Ultra channel. Not for LVDS operation.
8843	Wide/Ultra Flat Ribbon Cable	80 cm Wide/Ultra SCSI cable with four 68 pin HD SCSI connectors (male).	Connection of up to 3 internal Wide/Ultra SCSI devices per SCSI channel. Not for LVDS operation.
8844	Wide/Ultra2 and Ultra 160 Round Cable	3 meters Wide/Ultra2 and Ultra 160 Round Cable with stackable 68 pin VHD SCSI connector (male) and 68 pin HD SCSI connector (male). Both with thumb screws.	Connection of an external Wide/Ultra2 and Ultra 160 SCSI subsystem. For LVDS operation.
8877	Wide/Ultra2 and Ultra 160 Round Cable	1 meter Wide/Ultra2 and Ultra 160 Round Cable with stackable 68 pin VHD SCSI connector (male) and 68 pin HD SCSI connector (male). Both with thumb screws.	Connection of an external Wide/Ultra2 and Ultra 160 SCSI subsystem. For LVDS operation.
8845	Wide/Ultra2 and Ultra 160 SCSI Bracket	Bracket with two internal 68 pin HD SCSI connector (female) and two external 68 pin VHD SCSI connectors (female).	Connection of external Wide/Ultra2 and Ultra 160 SCSI subsystems. For LVDS operation.

8846	Narrow-Wide Bracket	External SCSI connector with an internal 68 pin connector (female) and an external 50 pin HD SCSI connector (female).	Connection of an external Narrow/Ultra SCSI subsystem with an internal Wide/Ultra channel. Not for LVDS operation.
8849	Wide/Ultra2 and Ultra 160 SCSI Bracket	Bracket with one internal 68 pin HD SCSI connector (female) and one external 68 pin VHD SCSI connector (female).	Connection of an external Wide/Ultra2 and Ultra 160 SCSI subsystem. For LVDS operation.
8850	Wide/Ultra2 and Ultra160 SCSI Bracket	Wide/Ultra2 and Ultra160 SCSI Bracket with one internal 68 pin HD SCSI connector (female) and one external 68 pin HD SCSI connector (female).	Connection of an external Wide/Ultra2 and Ultra 160 SCSI subsystem. For LVDS operation.
8951	LVDS/SE Terminator	Terminator for LVDS or SE buses with 68 pin HD SCSI connector (female). LEDs indicate, whether the bus/terminator is operating in SE or LVDS mode.	Termination of SE or LVDS 68 pin cables. For LVDS operation.
8952	LVDS/SE Terminator for SE/LVDS Hard Disks with SCA Connector.	Terminator for LVDS or SE buses with SCA connector for the hard disk and 68 pin HD SCSI connector (female). Connector for DC. Jumpers for SCSI-ID, Termination, Termpower, etc.	This product converts Wide/Ultra2 and Ultra 160 or Wide/Ultra hard disks with SCA connector into "normal" hard disks with termination (SE and LVDS), DC connector, Jumpers for SCSI-ID, etc.. For LVDS operation.
8953	External LVDS/SE Terminator	Stackable external Terminator for SE or LVD busses with 68 pin VHD SCSI connector (male). Thumb-Screws.	For LVDS operation.
8954	SCSI Wonder	External SCSI Bus Expander.	For all ICP Controllers, especially in Clustering systems

SE/LVD Terminator for 68 pin SE or LVDS cables.

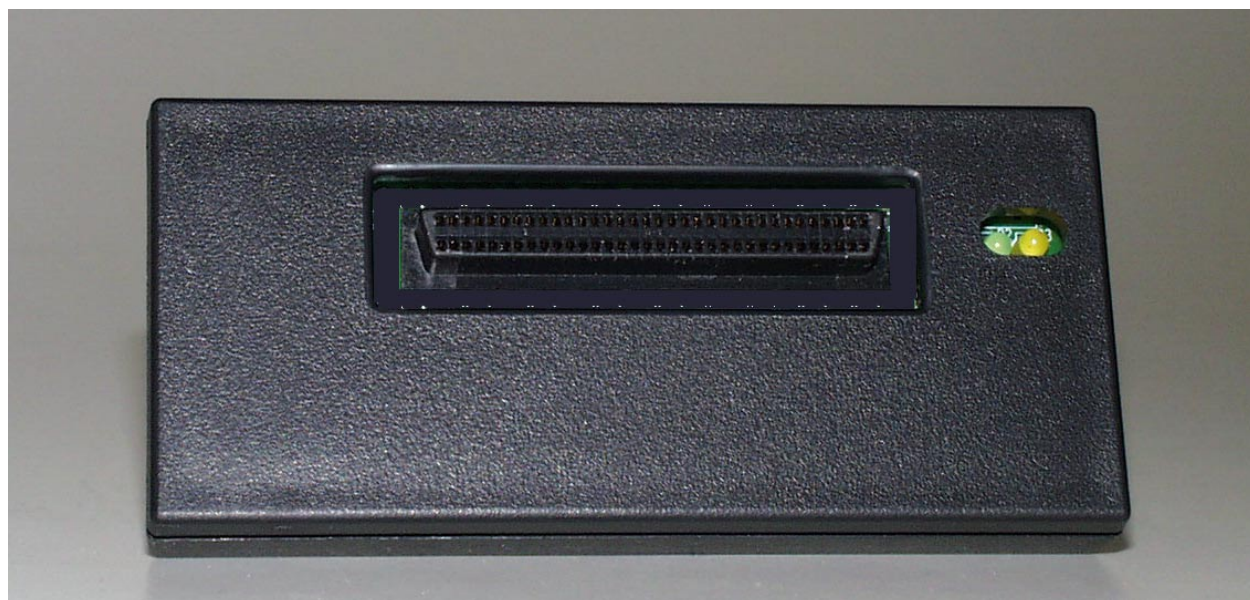

SE/LVD Terminator for SE/LVD hard disks with SCA connector.

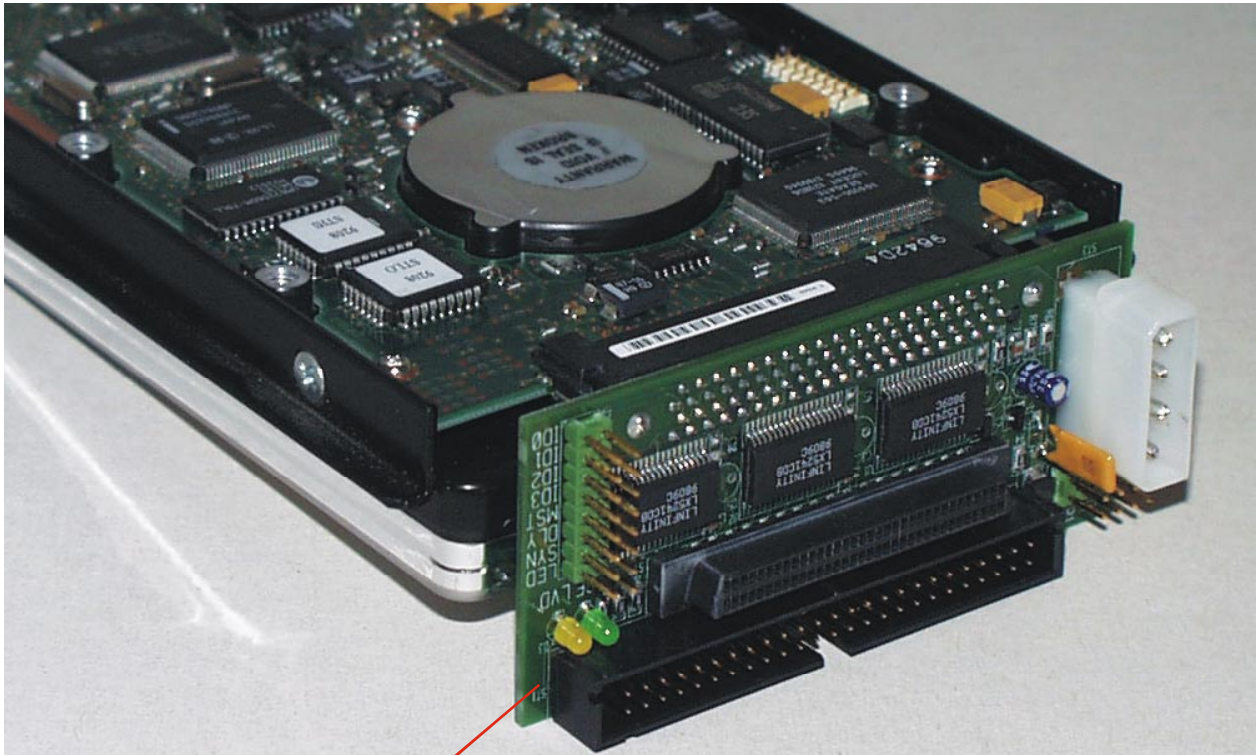

B.4.5 Examples

On the following pages, are some examples of correct SCSI cabling.

First of all a few general tips:

- All ICP Controllers have a yellow LED for each Wide/Ultra2 and Ultra 160 SCSI channel. This LED indicates the current SCSI-Mode of the corresponding channel. If the LED is lit, the Wide/Ultra2 and Ultra 160 SCSI channel is operating in LVDS-Mode. If the LED is not lit, this channel is operating in SE-Mode only. (The same applies to the SCSI accessories Art.No.: 8951 and 8952. There are two LEDs indicating the current SCSI-Mode: Green=SE, Yellow=LVDS).
- If you want to use hot-swap shelves for LVD disk drives, make sure that the shelf is fully LVD compliant, especially when several shelves are operated on one LVD channel. Whenever possible use for both, the shelf and the LVD disk drive, the SCA connector.

Several internal Wide/Ultra2 and Ultra 160 SCSI Hard Disks



Internal and external Wide/Ultra2 and Ultra 160 SCSI Hard Disks

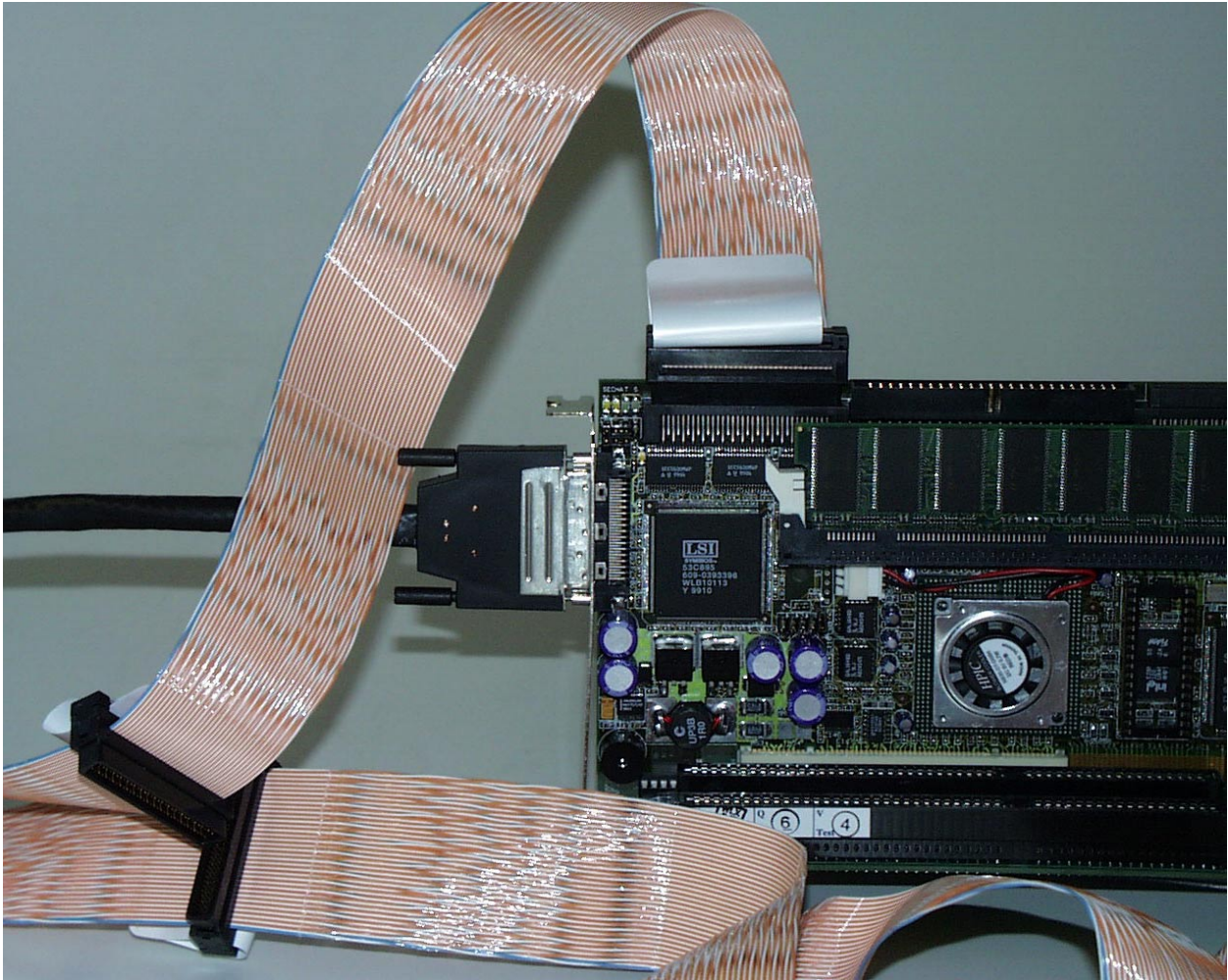

B.5 ICP Controller Installation

Make sure that the ICP Controller is equipped with an appropriate unbuffered PC100DIMM (at least 16MB). It is **not** possible to operate the ICP Controller without a DIMM.

Step 1

Switch off the PCI computer system and remove all cables (first of all the power supply).

Step 2

Following the instructions in the computer manual, open the case of the PCI computer, so that you have easy access to the PCI expansion slots.

Step 3

Select a free **64 Bit PCI bus-master slot** or **32 Bit PCI bus-master slot** and remove the metal bracket, following the instructions in your PCI computer manual. It is essential that the ICP Controller is plugged into a bus-master slot (it will NOT work in a slave or non-bus-master slot). Some motherboards have only 1 bus-master slot. Make sure that the selected slot has a sufficiently cooling airflow. Permanent overheating of electronic devices decreases their life time drastically. **If an ICP Controller of the RN Series is operated in a 32 Bit PCI bus-master slot, make sure that the unused card-edge connector of the ICP Controller has no contact with other components in the PCI slot area.** There are no further settings required to operate the ICP Controller in a 32 Bit or 64 Bit PCI bus-master slot.

Step 4

Push the ICP Controller firmly into the correct PCI bus-master slot. Make sure that the controller fits tightly into it, and that the external connectors stick out of the computer case. Now, fix the ICP Controller by tightening the screw of its bracket.

Step 5

To connect the external SCSI enclosures use suitable round cables (see ICP vortex SCSI Accessories – section B.4.4). Make sure that cables are fastened with the corresponding connectors.

To connect internal SCSI devices, use the internal SCSI connectors of the ICP Controller. You need 50-pin or 68-pin SCSI flat ribbon cables with appropriate connectors. Please verify that the colored core of the SCSI flat ribbon cable connects PIN1 of the ICP SCSI connector to PIN1 of the SCSI device (see ICP vortex SCSI Accessories – section B.4.4).

Step 6

If required, you can connect the HDD-front-LEDs of the PCI computer system to the LED connectors of the ICP Controller.

Step 7

Before the PCI computer system is switched on, check the following points over again:

- Is the PC100 DIMM installed properly into the socket ?
- Is the ICP Controller plugged firmly into one of the PCI bus-master slots ?
- Is the SCSI enclosure properly connected with the ICP Controller.
- Are the SCSI-IDs set correctly ?
- Are the SCSI-bus terminators plugged/set correctly ?
- Are the SCSI flat ribbon cables connected correctly ?

Step 8

After having checked all the points in "Step 7", reconnect the PCI computer system to the power supply. Do not close the computer case yet.

B.6 ICP Controller Function Check

Before we put the ICP Controller into operation for the first time, we would like to spend a few words on the PCI 2.x compatibility requirements a PCI computer system (especially the motherboard and the motherboard's BIOS) should meet.

B.6.1 PCI 2.2 Compatibility Requirements

Now, after having installed the ICP Controller and the devices, check whether the controller is working correctly. If the ICP Controller is the only controller in the computer system, set hard disks C: and D: to **not available** in the System-BIOS setup program of the computer.

Make sure that the boot priority starts with A, then C, etc..

Normally, you can start the BIOS setup program by pressing a certain key-combination after switching on the computer. After switching on the PCI computer system, pay attention to the LEDs of the ICP Controller.

- If everything is installed correctly, the green LED "S" will light up when switching on the PCI computer system. The green LED "S" (S for status) shows that the ICP Controller is online. If this green LED does not react as described above, switch off the PCI computer and double-check the correct installation of the ICP Controller.

- The electronic loudspeaker of the ICP Controller gives forth a series of 4 signals with a pause between the first two).
- The other green LED "T" may flicker sometimes (it always lights up during BUS-Master DMA transfers; the brighter it lights, the more DMAs).
- The yellow LEDs indicate accesses to the devices. They also may flicker occasionally as the ICP Controller scans the I/O channels for existing devices.

The ICP boot message appears. In the following example, a GDT7518RN Controller has been detected in PCI slot 3, and it has 32MB of RAM.

```

GDT - PCI      Disk Array Controller BIOS
Copyright (C) 1991-2000 by ICP vortex Computersysteme GmbH
All rights reserved!
BIOS located at 0x000E0000 - 0x000E1FFF
1 Controller(s) found, Selftests OK, scanning I/O channels ...
[PCI 0/3] DPMEM at 0x000D0000 - 0x000D3FFF INTA = IRQ10
[PCI 0/3] GDT7518RN -- HWLO -- 32 MB SDRAM/ ECC -- 2048kB Flash-RAM
[PCI 0/3] Serial-No. 00123412 -- RAIDYNE-FW-Version 2.21.00-Rxxx -- Jun 7 1998
[PCI 0/3] SCSI-A ID:0 LUN:0 -- SEAGATE ST19173LC
[PCI 0/3] SCSI-A ID:1 LUN:0 -- SEAGATE ST19173LC
[PCI 0/3] SCSI-A ID:2 LUN:0 -- SEAGATE ST19173LC
[PCI 0/3] SCSI-B ID:0 LUN:0 -- SONY CDROM
[PCI 0/3] SCSI-B ID:1 LUN:0 -- DLT2000XT
[PCI 0/3] RAID-5 Host Drive 1 installed (ready)

<<< Press <CTRL><G> to enter ICP RAID Console >>>

```

The single messages have the following meaning:

BIOS located at 0x000E0000 - 0x000E1FFF

Unlike ISA or EISA computers where the BIOS address of a peripheral expansion card is set manually (ISA, jumpers) or with the help of a configuration file (EISA, cfg file) and the address space is determined by the user, the PCI system-BIOS automatically maps the BIOS of a PCI compatible peripheral expansion card to a memory address. At each cold or warm boot, it determines which address space to assign to the BIOS of an expansion card. The message shown above reports the physical address occupied by the GDT BIOS.

[PCI 0/3]

PCI device, bus system **0**, slot **3**. The PCI 2.x specification allows several PCI bus systems to be present in one PCI computer. All ICP Controllers have been designed to support multiple PCI bus system computers. The slot number indicated in the message above does not refer to the 3rd PCI slot, but indicates that the ICP Controller is plugged into a slot which is the third one the PCI chipset of the PCI computer can access. To determine which physical PCI slot this corresponds to, consult the system manual of your PCI computer.

DPMEM at 0x000D0000 - 0x000D3FFF INTA = IRQ10

DPMEM stands for **D**ual **P**orted **M**EMory. The ICP Controller needs this address space of the PCI Computer for the command communication. As with the ICP Controller BIOS, this mapping, is also automatically carried out by the PCI system-BIOS. This information is essential when installing Expanded Memory Managers under DOS and Windows. The GDT DPMEM address space has to be excluded from the control of such a manager. (For more details, see chapter D of this manual). Furthermore, this messages tells us that the PCI **INT A** of the ICP Controller has been assigned to the system **IRQ10**. This assignment, is also carried out automatically if the PCI system-BIOS is 100% PCI 2.X compatible.

GDT7518RN -- HWLO -- 32 MB SDRAM / ECC - 2048kB Flash-RAM

GDT7518RN -- HWLO stands for the type of ICP Controller found by the GDT BIOS. HWL means Hardware level. **32 MB SDRAM /ECC** indicates that the installed DIMM is a 32MB ECC SDRAM module. Depending on the size of the installed PC100 DIMM the following messages are possible (xx = 16, 32, 64 and 128):

xx MB SDRAM/ECC xx MB ECC-SDRAM-Module

2048kB indicates the size of the installed Flash-RAM.

SCSI-A indicates SCSI devices which have been detected on the controller's SCSI channels.

<<< Press <CTRL><G> to enter ICP RAID Console >>>

After pressing this hot-key, the message **..... Please wait...** appears. The IO bus scan is completed and the built-in ICPCON configuration program is loaded. It allows you to configure RAID Array Drives.

B.6.1 Trouble Shooting

If these messages do not appear on the screen, or if other problems occur after switching on the computer system (screen remains dark etc.), you should check the entire installation over again:

- Are you using a functioning unbuffered PC100 DIMM (min. 16MB) ?
Try another one.
- DIMM plugged firmly into the socket ?
Unplug it and plug it in again.
- Is the ICP Controller plugged into a PCI bus-master Slot ?
Check this. If necessary, try another slot.
- Are the SCSI cables, the SCSI-IDs and the SCSI termination OK ?
Disconnect the cables from the ICP Controller. Try other cables.

B.6.2 Checking the ICP Controller Configuration

As mentioned before, these settings can be changed through soft-switches in the ICP Controller setup program ICPCON. All settings are permanently stored on the ICP Controller. The following table shows the various options and the possible settings.

Parameter / Function	Default-Setting
Cache	On
Delayed Write	On
BIOS	Enabled
BIOS Warning Level	Fatal Errors
SETUP from Flash-RAM	Enabled
Display <CTRL><G>	On
Supported BIOS Drives	2
CD-ROM Boot	Enabled
Memory Test	Standard
Chn. SCSI-x Termination	Auto
SCSI-ID of the SCSI/FC-AL channel	7



Chapter C

Quick-Setup

C. Quick-Setup

C.1 What is the Aim of Quick-Setup ?

In the previous chapter we installed the ICP Controller in a PCI computer and connected the SCSI devices. Now these devices must be prepared in order to run with your operating system. This **Quick-Setup** chapter should help you to get started quickly. Quick-Setup shows **three examples**:

- Example 1** Installing a single hard disk.
- Example 2** Installing a Mirroring Array Drive (RAID 1), consisting of 2 hard disks.
- Example 3** Installing a RAID 5 Array Drive, consisting of 3 identical hard disks, and adding one Hot Fix hard disk.

With example 3 some essential issues having direct impact on the structure and configuration of an Array Drive will also be discussed:

1. How many physical hard disks are to be integrated in the Array Drive ?
2. Which redundancy level ought to be achieved ?
3. Should the ICP Controller automatically recover redundancy in the event of a disk failure ? Or, in other terms: Are Hot Fix drives needed ?

Before we go through these examples, we would like to explain a few terms and relations important for the basic understanding of the ICP Controller firmware. At the end of example 3, we will try to answer the three questions above.

C.2 What is the ICP Controller Firmware ?

We refer to firmware as the operating system which controls the ICP Controller with all its functions and capabilities. The firmware exclusively runs on the ICP Controller and is stored in the Flash-RAM on the ICP Controller PCB. The controlling function is entirely independent of the PCI computer and the host operating system installed (for example UNIX), and does not "drain" any computing power or time from the PCI computer. According to the system requirements needed, the ICP Controllers are available with three firmware variants. The firmware is either already installed on the controller upon delivery, or can be added as an upgrade:

- **Standard Firmware** (installed on the GDTx1x8Rx and GDT7123RN controllers).
In addition to simple controlling functions regarding SCSI hard disks or removable hard disks, this version allows disk chaining (several drives can be linked in order to form a single "large" drive), and the configuration of Array Drives of the types data striping (RAID 0) and disk mirroring or duplexing (RAID 1).
Note: Use the RAIDYNE® Upgrade to install RAIDYNE®.
- **RAIDYNE®** (installed on the GDTx5x8Rx and GDTx5x3RN controllers).
In addition to disk chaining, RAID 0 and RAID 1, RAIDYNE® allows you to install Array Drives of the types RAID 4 (data striping with dedicated parity drive), RAID 5 (data striping with distributed parity) and RAID10 (a combination between RAID 0 and 1)

- **Cluster RAIDYNE®** (installed on the GDT76x8RN or GDT76x3RN controllers). In addition to disk chaining, RAID 0 and RAID 1, RAIDYNE® allows you to install and control Array Drives of the types RAID 4 (data striping with dedicated parity drive), RAID 5 (data striping with distributed parity) and RAID10 (a combination between RAID 0 and 1). Includes also functions to support Microsoft Cluster Server.

Note: RN Series ICP Controller with RAIDYNE® can be upgraded with the Cluster Module to the corresponding GDT76x8RN or GDT76x3RN controllers.

Unlike pure software solutions, e.g., Windows NT, the ICP Controllers a pure hardware RAID solutions. All ICP Controllers are equipped with a hardware which is particularly well suited for disk arrays. The ICP Controller firmware uses this hardware with extreme efficiency and therefore allows you to configure disk arrays that do not load the host computer (whereas all software-based RAID solutions more or less reduce the overall performance of the host computer.).

The basic concept of the ICP Controller firmware is strictly modular, and consequently, in its functioning it appears to the user as a unit construction system.

C.2.1 The Different RAID Levels

RAID 0 - Data Striping

According to the adjusted stripe size (e.g., 128 KB) and the number of hard disks, the data blocks are split into stripes. Each stripe is stored on a separate hard disk. Especially with sequential read and write operations, we can observe a significant improvement of the data throughput. RAID 0 includes no redundancy at all, i.e., when one hard disk fails, all data is lost.

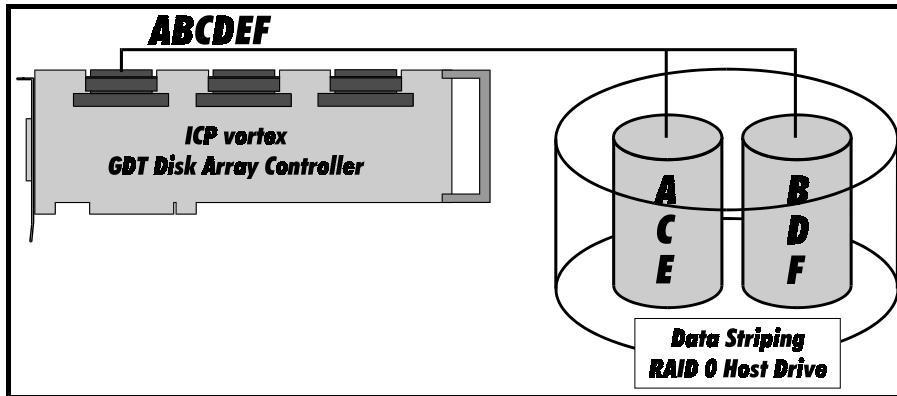

RAID 1 - Disk Mirroring/Disk Duplexing

All data is stored twice on two identical hard disks. When one hard disk fails, all data are immediately available on the other without any impact on the performance and data integrity.

We talk about "Disk Mirroring" when two hard disks are mirrored on one I/O channel. If each hard disk is connected with a separate I/O channel, this is called "Disk Duplexing" (additional security).

RAID 1 represents an easy and highly efficient solution for data security and system availability. It is especially suitable for installations which are not too large (the capacity available is only half of the installed capacity).

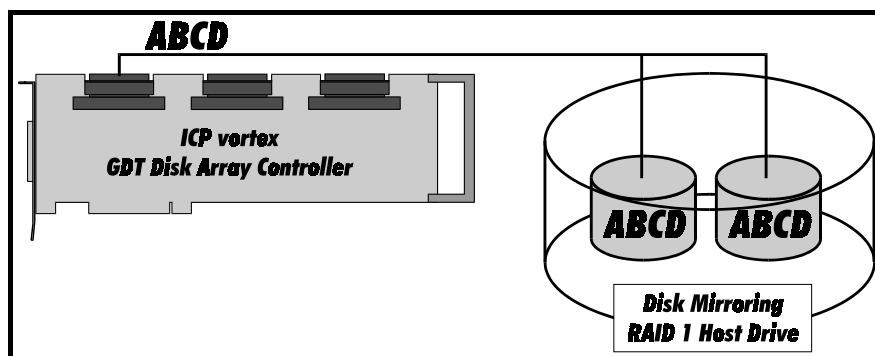

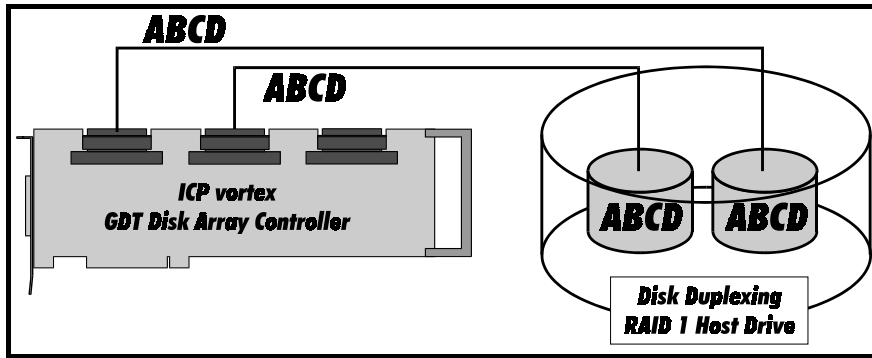

RAID 4 - Data Striping With a Dedicated Parity Drive

RAID 4 works in the same way as RAID 0. The data are striped amongst the hard disks. Additionally, the controller calculates redundancy data (parity information) which are stored on a separate hard disk (P1, P2, ...). Even when one hard disk fails, all data are still fully available. The missing data is recalculated from the data still available and the parity information. Unlike in RAID 1, only the capacity of one hard disk is needed for the redundancy. If we consider, for example, a RAID 4 disk array with 5 hard disks, 80% of the installed hard disk capacity is available as user capacity, only 20% is used for redundancy. In situations with many small data blocks, the parity hard disk becomes a throughput bottle-neck. With large data blocks, RAID 4 shows significantly improved performance.

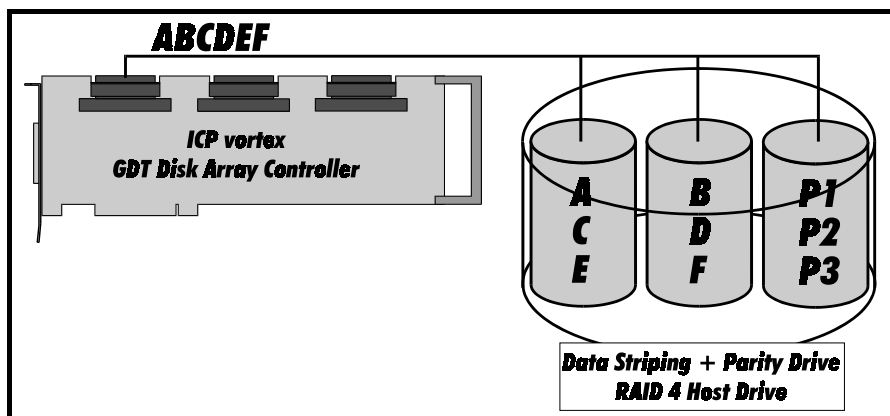

RAID 5 - Data Striping with Striped Parity

Unlike RAID 4, the parity data in a RAID 5 disk array are striped in all hard disks. The RAID 5 disk array delivers a balanced throughput. Even with small data blocks, which are very likely in a multi-tasking and multi-user environment, the response time is very good. RAID 5 offers the same level of security as RAID 4. When one hard disk fails, all data are still fully available, the missing data are recalculated from the data still available and the parity information. RAID 4 and RAID 5 are particularly suitable for systems with medium to large capacity requirements, due to their efficient ratio of the installed and actually available capacity.

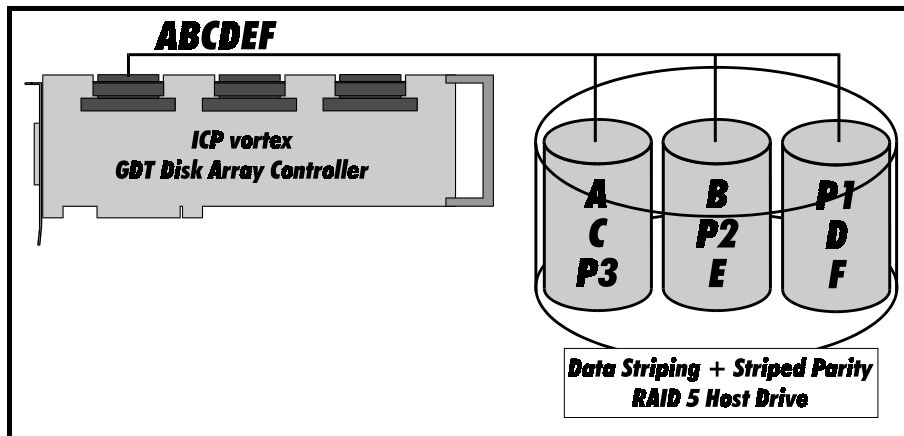

RAID 10 - Combination of RAID 1 and RAID 0

The idea behind RAID 10 is simply based on the combination of RAID 0 (Performance) and RAID 1 (Data Security). Unlike RAID 4 and RAID 5, there is no need to calculate parity information. RAID 10 disk arrays offer good performance and data security. As in RAID 0, optimum performance is achieved in highly sequential load situations. Identical to RAID 1, 50% of the installed capacity is lost for redundancy.

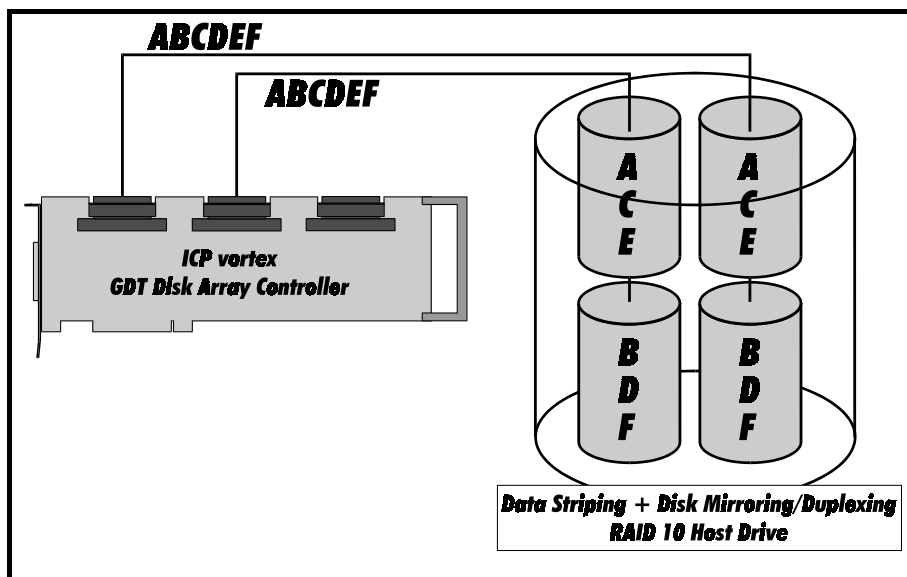

C.2.2 Levels of Hierarchy Within the ICP Firmware

The ICP firmware is based on four fundamental levels of hierarchy. Each level has its "own drives" (= components). The basic rule is:

To build up a "drive" on a given level of hierarchy, the "drives" of the next lower level of hierarchy are used as components.

Level 1:

Physical Drives = hard disks, removable hard disks, some MO drives are located on the lowest level. They are the basic components of all "drive constructions" you can set up. However, before they can be used by the firmware, these hard disks must be "prepared", a procedure we call *initialization*. During this initialization each hard disk receives information which allows a univocal identification even if the SCSI-ID or the controller is changed. For reasons of data coherency, this information is extremely important for any drive construction consisting of more than one physical drive.

Level 2:

On the next higher level are the **Logical Drives**. Logical Drives are introduced to obtain full independence of the physical coordinates of a physical device. This is necessary to easily change the whole ICP Controller and the channels, IDs, without losing the data and the information on a specific disk array.

Level 3:

On this level of hierarchy, the firmware forms the **Array Drives**. Depending on the firmware installed, this can be

- Single Disks (one hard disk, some vendors call it JBOD - Just A Bunch Of Drives)
- Chaining Sets (concatenation of several hard disks)
- RAID 0 Array Drives
- RAID 1 Array Drives, RAID 1 Array Drives plus hot fix drive
- RAID 4 Array Drives, RAID 4 Array Drives plus hot fix drive
- RAID 5 Array Drives, RAID 5 Array Drives plus hot fix drive
- RAID 10 Array Drives, RAID 10 Array Drives plus hot fix drive

Level 4:

On the highest level of hierarchy, the firmware forms the **Host Drives**. In the end, only these Host Drives can be accessed by the host operating system of the computer. Drives C, D, etc. under MS-DOS etc. are always referred to as Host Drives by the firmware. The same applies to NetWare- and UNIX-drives. The firmware automatically transforms each newly installed Logical Drive and Array Drive into a Host Drive. This Host Drive is then assigned a Host Drive number which is identical to its Logical Drive or Array Drive number.

The firmware is capable of running several Host Drives of the most various kinds at the same time. An example for MS-DOS: drive C is a RAID 5 type Host Drive (consisting of 5 SCSI hard disks), drive D is a single hard disk, and drive E is a CD-ROM communicating with RAIDYNE® through corelSCSI and the GDT ASPI manager.

On this level the user may split an existing Array Drive into several Host Drives.

After a capacity expansion of a given Array Drive the added capacity appears as a new Host Drive on this level. It can be either used as a separate Host Drive, or merged with the first Host Drive of the Array Drive. Within ICPCON, each level of hierarchy has its own special menu:

Level 1	⇒	Menu: Configure Physical Devices
Level 2	⇒	Menu: Configure Logical Drives
Level 3	⇒	Menu: Configure Array Drives
Level 4	⇒	Menu: Configure Host Drives

Generally, each installation procedure passes through these 4 menus, starting with level 1.

Therefore:

- First initialize the Physical Drives.
- Then configure the Logical Drives.
- Then configure the Array Drives (e.g. Array Drives with RAID 0, 1, 4, 5 and 10).
- Finally, configure the Host Drives.

C.2.3 Using CD-ROMs, DATs, Tapes, etc.

A SCSI device that is not a SCSI hard disk or a removable hard disk, or that does not behave like one, is called a **Not Direct Access Device**. Such a device is **not configured with ICPCON and does not form a Logical or Host Drive**. SCSI devices of this kind are either operated through the ASPI interface (Advanced SCSI programming Interface) (MS-DOS, Windows, Novell NetWare or OS/2), or are directly accessed from the operating system (UNIX, Windows NT). For more information on how to use these devices, please refer to the corresponding chapters of this manual. Note: hard disks and removable hard disks are called *Direct Access Devices*. However, there are some *Not Direct Access Devices*, for instance certain MO drives, which can be operated just like removable hard disks if they have been appropriately configured before (for example by changing their jumper setting).

But enough on the dry theory. Now here are the examples which explain step by step all the necessary basics for setting up Host Drives with your ICP Controller

C.3 Example 1 - Installing a Single SCSI Hard Disk

Press the <CTRL><G> key combination when the ICP BIOS message comes up (shortly after switching on the computer) and load ICPCON from the Flash-RAM of the ICP Controller. In this case no operating system is required.

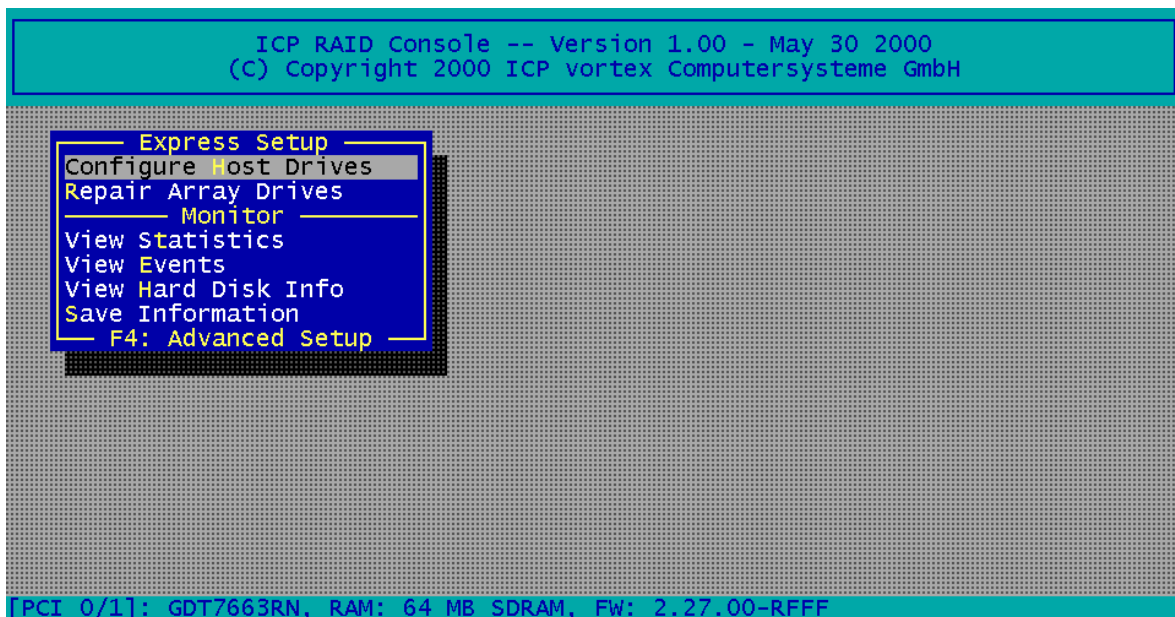

Select the menu option Configure Host Drives with ENTER.

Select Host Drive							
No.	Name	Status	Attr.	Capacity	Type	belongs to	
0	RAID5	ready	RW	17495 MB	RAID-5	Array	0
Create new Host Drive							
F4: Drive Information, F5: Identify Drive, F10: Refresh							

The list of available Host Drives contains already an entry. There is a RAID 5 Host Drive. After selecting Create new Host Drive ICPCON displays a list of "free" hard disks. These are all the drives which do not belong to a Logical or Host Drive and can be used for new Host Drives. Select a hard disk with the SPACE bar (it becomes marked with an "*") and press ENTER.

Select Physical Drive							
Chn	ID	LUN	Vendor	Product	Attr	Cap(MB)	Drive
* SCSI-A	0	0	QUANTUM	ATLAS10K2-TY184J	RW	17510	
SCSI-A	10	0	FUJITSU	MAF3364LC	RW	34746	
SCSI-A	11	0	FUJITSU	MAF3364LC	RW	34746	
SCSI-A	12	0	FUJITSU	MAF3364LC	RW	34746	
SCSI-B	1	0	SEAGATE	ST39175LC	RW	8683	
SCSI-B	2	0	SEAGATE	ST39175LC	RW	8683	
SCSI-B	3	0	SEAGATE	ST39175LC	RW	8683	
SCSI-B	4	0	SEAGATE	ST39175LC	RW	8683	
SCSI-B	15	0	QUANTUM	ATLAS10K2-TY184J	RW	17510	
SCSI-C	14	0	QUANTUM	ATLAS10K2-TY184J	RW	17510	
SCSI-D	0	0	QUANTUM	ATLAS10K2-TY184J	RW	17510	

SPACE: Select/deselect drive, ENTER: End selection

Since we have only one hard disk selected, in the Choose Type menu, the only possible (high-lighted) entry is Single Disk. Press ENTER. For security reasons, you will be asked if you want to use the selected disk to create a Host Drive.

Do you want to create a host Drive from the selected disk(s) ?
(CAUTION: All data will be destroyed !) (Y/N)

Choose Type	
Single Disk	
Chaining	
RAID 0	
RAID 1	
RAID 1 + HotFix	
RAID 4	
RAID 4 + HotFix	
RAID 5	
RAID 5 + HotFix	
RAID 10	
RAID 10 + HotFix	

As we are sure of our choice, we confirm with <Yes>.

ICPCON creates a new Host Drive now. All parameters of the hard disk are adjusted automatically at optimum level.

ICP RAID Console -- Version 1.00 - May 30 2000
(C) Copyright 2000 ICP vortex Computersysteme GmbH

Express Setup							
Configure Host Drives							
Select Host Drive							
No.	Name	Status	Attr.	Capacity	Type	belongs to	
0	RAID5	ready	RW	17495 MB	RAID-5	Array	0
4	PD_A000	ok	RW	17509 MB	Disk	Logic.	4
Create new Host Drive							
F4: Drive Information, F5: Identify Drive, F10: Refresh							
F4: Advanced Setup							

PCI 0/11: GDT7663RN. RAM: 64 MB SDRAM. FW: 2.27.00-RFFF

The new Host Drive is assigned a Host Drive Name (here PD_A000) which helps for better identification, especially in configurations with many different Host Drives. The name can be easily changed.

C.4 Example 2 - Installing a Mirroring Array - RAID 1

Press the <CTRL><G> key combination when the ICP BIOS message comes up (shortly after switching on the computer) and load ICPCON from the Flash-RAM of the ICP Controller. In this case no operating system is required.

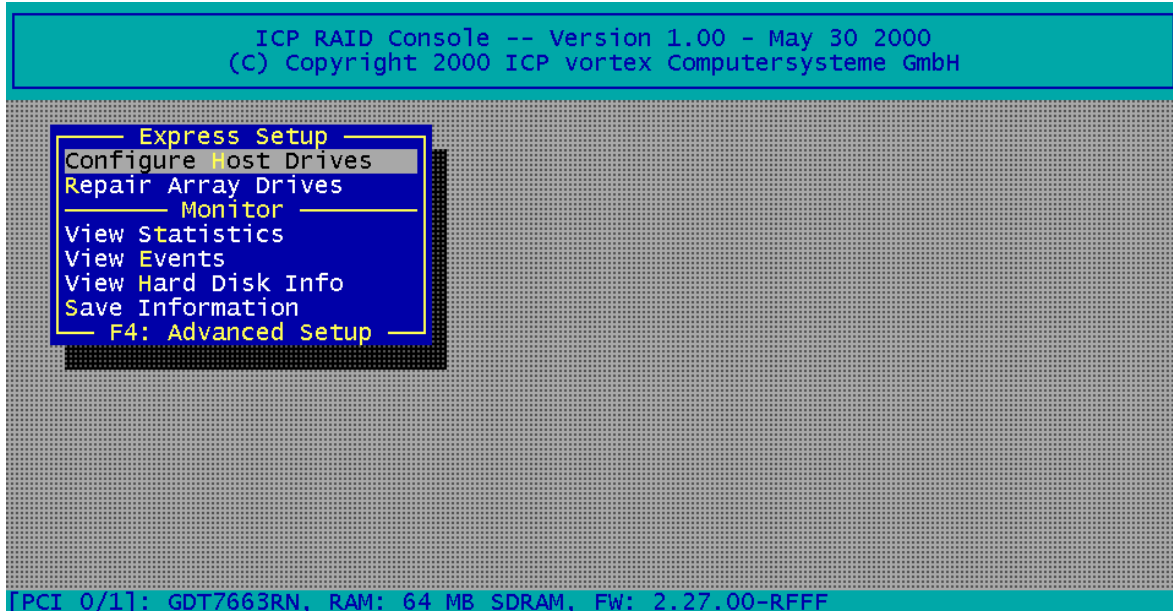

Select the menu option Configure Host Drives with ENTER.

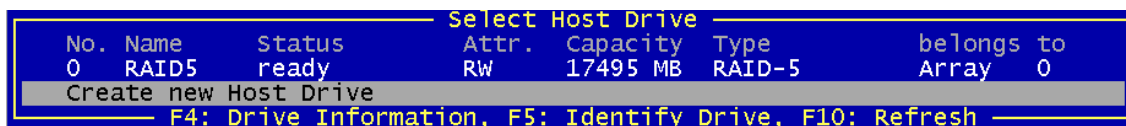

The list of available Host Drives contains already an entry. There is a RAID 5 Host Drive. After selecting Create new Host Drive ICPCON displays a list of "free" hard disks. These are all the drives which do not belong to a Logical or Host Drive and can be used for new Host Drives.

Select two hard disks with the SPACE bar (these hard disks become marked with an "*") and press ENTER.

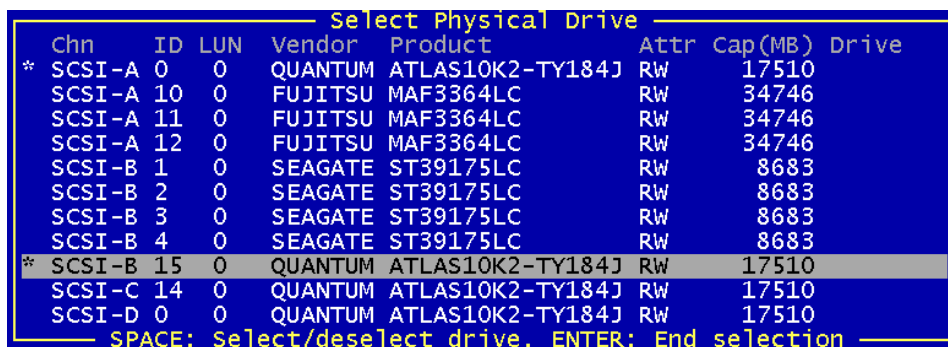

Move the selection bar with the cursor keys from one entry to another (pressing the SPACE bar again undoes your choice).

The Choose Type menu offers four different Host Drive Types. For this example we select RAID 1 and press ENTER. ICPCON displays a warning that all data will be destroyed after confirmation.

Do you want to create a host Drive from the selected disk(s) ?
(CAUTION: All data will be destroyed !) (Y/N)

```

Choose Type
Single Disk
Chaining
RAID 0
RAID 1
RAID 1 + HotFix
RAID 4
RAID 4 + HotFix
RAID 5
RAID 5 + HotFix
RAID 10
RAID 10 + HotFix
  
```

ICPCON allows you to limit the hard disk size for this Host Drive. This becomes interesting when you configure disk arrays and you want to make sure that future drives you want to bring into the disk array for

Used Capacity per Drive (1..17509 MB): 17000_

replacement purposes) fit. It would be bad luck if the new drive only had 17508 MB. ICPCON couldn't accept

it. To avoid this occurring, you could limit the capacity of each drive to 17000 MB. Any new 18 GB drive must have at least this capacity. The 509 MB in our example would be lost. For this example we use the full capacity and press ENTER. The new Host Drive is created. It's status is still build, since the ICP Controller synchronizes both drives.

Select Host Drive						
No.	Name	Status	Attr.	Capacity	Type	belongs to
0	RAID5	ready	RW	17495 MB	RAID-5	Array 0
4	PD_A000	build	RW	17000 MB	RAID-1	RAID-1 4

Create new Host Drive
F4: Drive Information, F5: Identify Drive, F10: Refresh

Upon successful completion of this process the status of this RAID 1 Disk Array changes into ready, i.e., the data is fully redundant.

The functioning of a RAID-1, or mirroring, disk array, is easy to understand: On the ICP Controller, one write-access from the host computer is transformed into two write-accesses (to both Logical Drives forming the mirroring array). If the two Logical Drives are built of hard disks, which are connected with different SCSI channels of the ICP Controller, both write-accesses are performed simultaneously (this method is often called *Disk Duplexing*). During a read-access of the host computer the data will be read from the Logical Drive whose hard disk has the fastest access to the data requested.

If a hard disk should fail (for instance due to a mechanical defect), all data is still available on the other Logical Drive. In this event, the controller gives an acoustical alarm.

C.5 Example 3 - Installing a RAID 5 Disk Array

This example is applicable to ICP Controllers with the RAIDYNE® firmware.

Press the <CTRL><G> key combination when the ICP BIOS message comes up (shortly after switching on the computer) and load ICPCON from the Flash-RAM of the ICP Controller. In this case no operating system is required.

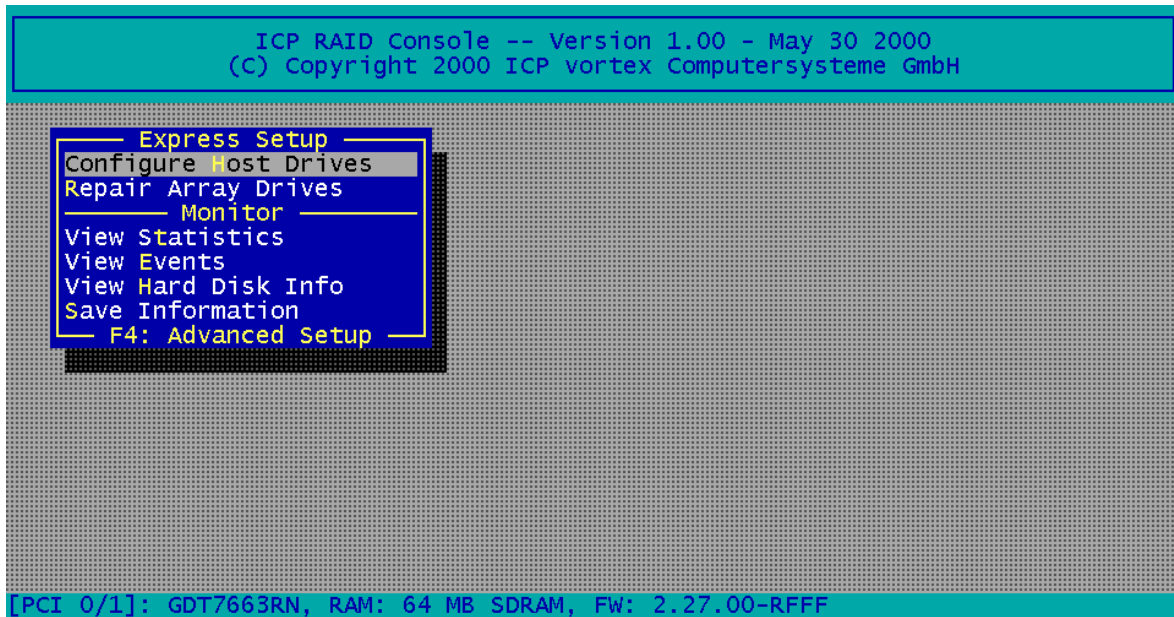

Select the menu option Configure Host Drives with ENTER.

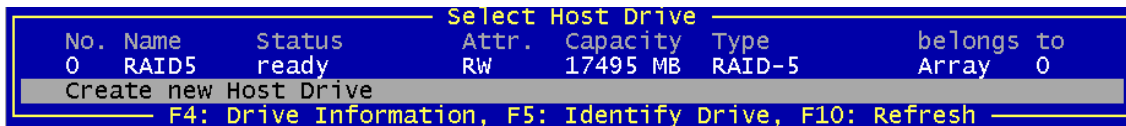

The list of available Host Drives contains already an entry. There is a RAID 5 Host Drive. After selecting Create new Host Drive ICPCON displays a list of "free" hard disks. These are all the drives which do not belong to a Logical or Host Drive and can be used for new Host Drives.

Select four hard disks with the SPACE bar (these hard disks become marked with an "*") and press ENTER.

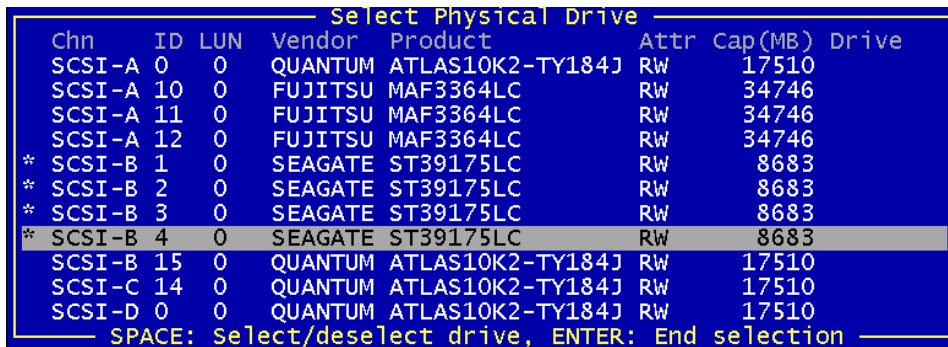

Move the selection bar with the cursor keys from one entry to another (pressing the SPACE bar again undoes your choice).

The Choose Type menu offers several different Host Drive Types. For

Do you want to create a host Drive from the selected disk(s) ?
(CAUTION: All data will be destroyed !) (Y/N)

this

For this example we select RAID 5 + Hot Fix and press ENTER. ICPCON displays a warning that all data will be destroyed after confirmation.

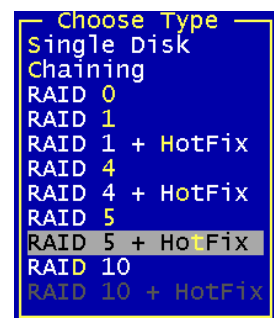

ICPCON allows you to limit the hard disk size for this Host Drive. This becomes interesting when you configure disk arrays and you want to make sure that future drives you want to bring into the disk array (for replacement or online capacity reasons) fit. It would be bad luck if the new drive

Used Capacity per Drive (1..8682 MB): 8000_

only had 8681 MB. ICPCON couldn't accept it. To avoid this occurring, you could limit the capacity of each drive to 8000 MB. Any new 9 GB drive must have at least this capacity. Press ENTER

The new Host Drive is created. It's status is still build, since the ICP Controller creates the parity information on all drives.

Select Host Drive							
No.	Name	Status	Attr.	Capacity	Type	belongs to	
0	RAID5	ready	Rw	17495 MB	RAID-5	Array	0
4	RAID5	build	Rw	16000 MB	RAID-5	Array	4

Create new Host Drive
F4: Drive Information, F5: Identify Drive, F10: Refresh

When leaving ICPCON, a progress information informs you about the Estimated time for this build process and the time it already runs.

Progress Information: Non-destructive Array Build	
Elapsed Time: 00:08:50	Estimated Time: 00:30:25 34 %
Press ESC to quit	

Upon successful completion of this process the status of this RAID 5 Disk Array changes into ready, i.e., the data is fully redundant.

In case of a drive failure, the ICP Controller automatically starts the Hot Fix Drive and builds it into the Disk Array. The status of the Disk Array would be rebuild and finally ready, again.

C.6 Trying to Answer The Initial Questions

C.6.1 How Many Hard Disks Should be Integrated Into the Disk Array ?

To answer this question let us have a look at the delimiting parameters, that is, the maximum and minimum number of drives. The **maximum number** of physical drives in a disk array is determined by the number of physical drives the ICP Controller can. In this context, we cannot analyze the many various factors which influence the decision of whether to integrate all Host Drives into one single RAID Host Drive, or rather create a number of smaller RAID Host Drives instead. The **minimum number** of necessary hard disks depends on the RAID level you wish to realize.

RAID Level	Type of Disk Array	Minimum number of hard disks
RAID 0	data striping	2
RAID 1	disk mirroring	2
RAID 4	data striping with parity drive	3
RAID 5	data striping with striped parity	3
RAID 10	data striping and mirroring	4

The desired usable disk space of the disk array as well as the following two issues have a direct impact on the number of physical hard disks needed.

C.6.2 Which Level of Redundancy is Needed ?

To come straight to the point, **RAID 0** (data striping) does not imply any redundancy at all (the **R** in front of the **AID** is rather misleading). On the other hand, a RAID 0 disk array is pretty fast, since no parity information is required. With **RAID 1** (disk mirroring), the data is 100% redundant because it is mirrored. This is definitely the highest level of redundancy, but the most expensive one, too. An interesting combination of RAID levels 0 and 1 is **RAID 10**. Two RAID 0 stripe sets are simply mirrored. If one drive fails, the data are still available on the mirrored drive. With **RAID 4** (data striping with dedicated drive) and **RAID 5** (data striping with striped parity), parity information is calculated from the present data with a simple mathematical operation (eXclusive OR, XOR), and stored either to one dedicated drive (RAID 4) or to all drives (RAID 5). If one drive should fail, the data of the defective drive can be reconstructed on the basis of the normal user data and the previously calculated parity data. RAID levels 4, 5 and 10 can tolerate the failure of one drive just as RAID 1, but in comparison to the latter, RAID 4, RAID 5 or RAID 10 are less expensive.

As already mentioned before, the entire disk array controlling function is carried out at controller level and therefore does not load the host computer.

Let us have a look at the following table which explains the correlation between the RAID level, usable disk capacity and number of physical hard disks. To make things easier, we consider identical 1 GB hard disks:

Usable storage capacity of the disk array

RAID Level	2 hard disks	3 hard disks	4 hard disks	5 hard disks
RAID 0	2GB	3GB	4GB	5GB
RAID 1	1GB	1GB	1GB	1GB
RAID 4	-	2GB	3GB	4GB
RAID 5	-	2GB	3GB	4GB
RAID 10	-	-	2GB	-

It is quite obvious that the redundancy of level RAID 1 soon becomes very expensive when more than 2 hard disks are used. Only with RAID 4 and RAID 5 have you a reasonable relation between storage capacity and expenses for the disk array.

C.6.3 Do we Need Hot Fix drives ?

In other words: Should RAIDYNE® automatically reconstruct the lost data after a hard disk failure ? One of the reasons that have led you to choose **RAID** disk arrays definitely lies with the **redundancy**, that is, the data security you still preserve even in the event of disk failure, thus resting assured against loss of data and time. Hot Fix drives are possible with all RAID 1, 4, 5 and 10 disk arrays. In order to assist the following considerations, we define the term **time without redundancy, TWR**. Set apart the time needed to set up the disk array (state *build*), the time without redundancy should be kept as short as possible. Let us assume that one of the hard disks of the RAID 5 disk array we set up with example 1 fails. The disk array is without redundancy. TWR starts to run. Any superfluous prolongation of the TWR (because you have to get a replacement drive, or because you did not realize the failure immediately since you didn't hear the ICP Controller's alarm signal, or because nobody checked the file server) increases the risk of data loss which will occur if a second drive should fail. Therefore, new redundancy should be created as soon as possible and in an entirely automated manner. Integrating a Hot Fix drive as an immediately available and auto-replacing drive is the only way to keep the TWR as short as possible. Only a Hot Fix drive can ensure optimal disk array security and constant data availability. Of course a Hot Fix drive is not compulsory. If you control the disk array at regular intervals and immediately replace a defective drive (by shutting down the system or hot-plugging), you can do without a Hot Fix drive.

C.7 States of a RAIDYNE® Disk Array

An Array Drive under the RAIDYNE® operating system can assume seven different operational modes: **Idle**, **Ready**, **Fail**, **Build**, **Rebuild**, **Expand** and **Error**.

C.7.1 "Idle" State

This state is characterized by the fact that the redundant information of the disk array has never been entirely created. The disk array is in this state after its first configuration and until you quit ICPCON. If an error should occur while the array is in the *build* state, the array returns to the *idle* state (exception: if during *build* mode the dedicated drive of RAID 4 fails, the mode changes to *fail*).

C.7.2 "Build" State

After the disk array has been configured for the first time, it assumes the *build* state as soon as you quit ICPCON. While the array is in the *build* state, redundancy information is calculated and stored to the hard disks of the array.

C.7.3 "Ready" State

The disk array is fully operational when in the *ready* state. All redundant information is present, that is, a hard disk can fail without impairing the functionality of the disk array. This is the normal state of a disk array. The state *ready/expand* indicates, that the RAID level and/or capacity are currently migrated/expanded.

C.7.4 "Fail" State

The disk array changes to the *fail* state whenever a Logical Drive fails. Redundancy information is still present, thus allowing the remaining hard disks to continue working. This state should be eliminated as soon as possible by replacing the defective hard disk. If a so-called Hot Fix drive has previously been assigned to a disk array with ICPCON, the controller will automatically replace the defective drive and start the reconstruction of the data and the redundant information. Therefore, under these circumstances the *fail* state is only temporary and will be eliminated by the controller itself.

C.7.5 "Rebuild" State

The disk array will assume this state after the automatic activation of a Hot Fix drive or after a manual replacement carried out with ICPCON. The data and the redundant information are reconstructed and stored to the new drive.

C.7.6 "Expand" State

If the capacity or RAID level of an existing disk array is changed, the disk array changes its state into *expand*. As soon as the expansion or migration is completed, the state changes back to *ready*.

C.7.7 "Error" State

If a second hard disk should fail while the disk array is in the *fail* or *rebuild* state, it is not possible to continue the working session without restrictions. The disk array is still available for I/Os, but data loss and error messages on the host level are possible. The following state diagram of the disk array summarizes the states described above and the transitions from one state to another.

C.8 Methods for the Replacement of a Disk Drive

The ICP Controller and the ICP Firmware offer a variety of possibilities to replace a defective disk drive. If and when to use them depends on the physical environment of your server. With some servers the disk drives are just mounted into the server enclosure, they are not removable. With other servers there is a backplane which is intelligent (e.g., with SAF-TE) and which hosts a number of disk drives with the SCA connector (Single Connector Attachment). Another type of server has the disk drive in hot pluggable disk carriers which have become pretty popular during the last 2 years. These carriers are often "stupid" and do not communicate with the ICP Controller or server. Though, they can display the disk drive's temperature or the status of their build in fan.

	<i>Manual Hot Plug</i>	<i>Auto Hot Plug</i>	<i>Automatic Replacement with Hot Fix Drive</i>
<i>Typical Server Environment</i>	<p>Low Cost.</p> <p>Disk Drives are physically mounted in the server enclosure and are not removable.</p>	<p>Additional cost for external enclosure, cables, backplanes, etc..</p> <p>Disk Drives are installed removable in an intelligent or non-intelligent subsystem. The subsystem complies with one of the following enclosure standards:</p> <ul style="list-style-type: none"> ▪ "SAF-TE" (SCSI Accessed Fault Tolerant Enclosures) ▪ "SES" (SCSI Enclosure Services) ▪ "Intelligent Fault Bus" (former DEC™ fault bus) ▪ Non-Intelligent Subsystems using hot pluggable disk carriers 	<p>High availability.</p> <p>Right from the beginning, the ICP Controller has a spare drive. In the case that one drive of an Array Drive has failed, the spare drive (we at ICP call it Hot Fix Drive), is automatically build into the Array Drive. Without any user interaction the Array Drive is becoming, redundant, again.</p>
<i>Description</i>	<p>ICP RAID Console or ICP RAID Navigator guides the user to the point where the new disk drives can be build into the Array Drive.</p>	<p>The subsystem has to be configured with ICP RAID Console or ICP RAID Navigator, before the Auto Hot Plug can work. Thereafter a disk drive can just be pulled out and plugged in again, and the ICP Controller "knows" what to do. In addition, SAF-TE and SES report the enclosure status (power supplies, fans, temperature etc.) to the ICP Controller and the ICP driver.</p>	<p>The Hot Fixe Drive is assigned to an Array Drive. There are two types of Hot Fix Drives:</p> <ul style="list-style-type: none"> ▪ Private Hot Fix Drive (Available for one Array Drive, only) ▪ Pool Hot Fix Drive (Several Array Drives share this Hot Fix Drive)



Chapter D

Using MS-DOS

D. Using Microsoft MS-DOS

After having explained the installation of the ICP Controller and the Host Drives in chapters B and C, we now explain how to install the operating system MS-DOS. By using some examples, we shall demonstrate how to use a CDROM drive (standing for any other *Not Direct Access Device*) under MS-DOS. In addition, we will give you further information on how to install **Windows 95 and Windows 98**. The required ICP disks for DOS and Windows 95/98 can be created from the ICP System CDROM.

D.1 Transparency of Host Drives

The structure of the Host Drives, which have been installed with ICPCON (in chapter C), is not known to DOS. i.e., the operating system does not recognize that a given Host Drive consists of a number of hard disks forming a disk array. To DOS this Host Drive simply appears as one single hard disk with the capacity of the disk array. This complete transparency represents the easiest way to operate disk arrays under DOS; neither DOS nor the PCI computer need to be involved in the administration of these complex disk array configurations.

D.2 Partitioning a Host Drive and Transferring MS-DOS

You can partition the Host Drives installed in chapter C with ICPCON as well as with the MS-DOS program FDISK. Some users ignore that an MS-DOS boot partition has to have the state "**active**". If the partition is not active, the system will attempt to boot MS-DOS, but will "hang" straight away. Very often, the system message "ROM BASIC NOT FOUND, SYSTEM HALTED" is displayed (in the 40 lines of text mode). You can easily remedy this problem by booting the system from an MS-DOS floppy disk, and then activating the partition with ICPCON or FDISK (for more information on FDISK please refer to the MSDOS user's manual).

After creation of a primary MS-DOS partition use the MS-DOS program FORMAT to transfer MS-DOS. To do so, enter

```
A:\> FORMAT C: /S ENTER
```

To complete the installation of MS-DOS, use the MS-DOS commands COPY or XCOPY to transfer the desired MS-DOS files.

A different and maybe even more elegant method of installing MS-DOS is to use the SETUP program of MS-DOS versions 5 and 6. In this case, you only have to create and activate a partition with ICPCON or FDISK. Then boot the system from the first floppy disk delivered with MS-DOS. MS-DOS SETUP will take care of all the rest.

D.3 CONFIG.SYS and the Driver GDTX000.EXE

GDTX000.EXE is the high performance MS-DOS driver for all ICP Controllers. In order to obtain the best performance of the ICP Controller under MS-DOS, this driver should be listed in the first line following the HIMEM.SYS device command in the CONFIG.SYS file. When loaded, GDTX000.EXE replaces the BIOS EPROM (the so-called INT13H interface) of the ICP Controller, and also offers a VDS (Virtual DMA Services) interface. This is of particular importance for Windows 3.x. When using GDTX000.EXE please observe the following:

- GDTX000.EXE must be loaded from the first line following the HIMEM.SYS device command in the CONFIG.SYS file. If HIMEM.SYS is not loaded, it must be loaded from the very first line of the CONFIG.SYS file.

- GDTX000.EXE can be loaded in the UMA.
- GDTX000.EXE is needed for an optimal use of Windows 3.x.
- The ICP Controller unfolds its full capacity under MS-DOS or Windows 3.x only when GDTX000.EXE is installed.
- In order to load ICPCON under MS-DOS from disk, you need GDTX000.EXE.
- In the CONFIG.SYS file, GDTX000.EXE must be loaded before GDTASPI.EXE.

Below is an example of a CONFIG.SYS file which is essential for the MS-DOS configuration

```
device=c:\windows\himem.sys
device=gdtx000.exe
files=30
buffers=30
stacks=9,256
dos=high,umb
install=\dos\keyb.com GR,,\dos\keyboard.sys
device=mouse.sys
device=\dos\setver.exe
device=\gdt\gdtaspi.exe
device=\aspi\aswcdnec.sys /D:CDROM
lastdrive=h
```

In this example, besides the GDTX000 driver, the GDTXDOS.EXE driver, the GDT ASPI Manager and an ASPI Module for an NEC CDROM drive are loaded.

D.4 Expanded Memory Managers

When using Expanded Memory Managers, a certain address area has to be excluded from being controlled by these programs. This area is the ICP Dual Ported Memory address space. If the ICP Controller is not run with the GDTX000.EXE driver (that is, the driver has not been loaded from the CONFIG.SYS file), the address space of the ICP BIOS must also be excluded. If the GDTX000.EXE driver is loaded from the CONFIG.SYS file in a line **before** the Expanded Memory Manager (EMM), it is not necessary to exclude the address space of the ICP BIOS. Unlike ISA or EISA computer systems where the controller's BIOS address space is set manually (through jumpers or the configuration file), PCI computers automatically map the address space of a peripheral PCI device (e.g., the ICP Controller with its BIOS and Dual Ported Memory) to a suitable location during a warm or cold boot. If the system configuration does not change (no new PCI expansion cards are being added etc.), the PCI System BIOS will always map these two spaces to the same addresses. To help you find out where these addresses have been mapped to, the ICP BIOS indicates the physical address locations of the ICP BIOS and the ICP DPMEM during the cold boot (also see chapter B in this manual):

BIOS located at 0x000E0000 - 0x000E1FFF

In this example, the ICP BIOS occupies E000:0000 to E000:1FFF (E000 is the segment address).

DPMEM at 0x000D0000 - 0x000D3FFF

Here the DPMEM starts at D000:0000 and ends at D000:3FFF (D000 is the segment address).

You may also use other utility programs such as *Georg Schnurer's (c't magazine) CTPCI* program in order to obtain the requested address locations. On this occasion we would like to

thank Mr. *Georg Schnurer* and the *c't magazine* for allowing us to use this very helpful utility on our system disks.

Example 1: The Microsoft EMM386.EXE Manager is used. The ICP driver GDTX000.EXE has not been loaded from the CONFIG.SYS:

```
DEVICE=EMM386.EXE X=D000-D3FF X=E000-E1FF
```

Example 2: The Microsoft EMM386.EXE Manager is used. The ICP driver GDTX000.EXE has been loaded from the CONFIG.SYS:

```
DEVICE=EMM386.EXE X=D000-D3FF
```

(Note: You may have to add the path for "EMM386.EXE". Other parameters may follow the excluded areas).

D.5 Using a CDROM Drive under MS-DOS

CDROM drives (as well as tape streamers, WORM drives and most MOD drives, too) belong to the category of the so-called **Not Direct Access Devices**. They **cannot** be installed with ICPCON or FDISK and FORMAT and they are not directly supported by MS-DOS or Windows - unlike, for example, hard disks and removable hard disks. To install and access these devices, a special standard, the so-called ASPI Standard (Advanced SCSI programming Interface), has been created. While the manufacturer of the controller (in this case ICP) has to offer the ASPI Manager, the manufacturer of the SCSI device (CDROMs etc.) has to provide an ASPI Module (note: there are some companies which have specialized in the development of ASPI modules, for example Corel Corp. with its product **corelSCSI**; the ICP Controller is certified by Corel). Both units, the SCSI controller and the SCSI device, communicate through this ASPI interface. It is not a hardware interface (like, for example, Centronics, SCSI or RS232), but a pure software interface. The following illustration explains this interface:

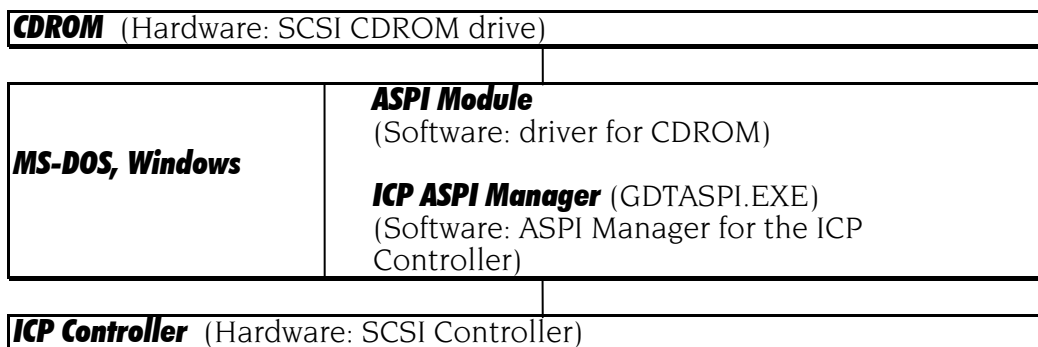

With the following two examples we demonstrate how to install a CDROM drive for use with the ICP Controller under MS-DOS and Windows. The installation differs slightly, depending on whether you use the corelSCSI software or the ASW software. Regardless of which software you choose to use, the ASPI manager of the ICP Controller (located on the GDT *System Disk* - DOS) has to be loaded from the CONFIG.SYS file. The objective of both installations is to make the CDROM drive accessible as a drive (for example drive E) under MS-DOS or Windows, and to be able to access this drive just as if it were a (write-protected) floppy disk in drive A or B.

At this point we presume that the CDROM drive has been properly connected to the ICP Controller. This includes that the SCSI-ID and the SCSI bus terminators are set in accordance with the settings of the already existing SCSI devices (i. e., the SCSI-ID chosen for the CDROM drive is not occupied by another device; resistor terminators are located only at the two ends of the SCSI bus).

D.5.1 Example: Using the ASW Software for the CDROM

The important lines in both files are printed bold.

CONFIG.SYS

```
device=c:\windows\himem.sys
device=gdtx000.exe
files=30
buffers=30
stacks=9,256
dos=high,umb
shell=\COMMAND.COM /E:512 /P
device=\dos\setver.exe
device=\gdt\gdtaspi.exe
device=\aspi\aspicd.sys /D:CDROM
lastdrive=h
```

AUTOEXEC.BAT

```
path=c:\;c:\dos;c:\gdt;c:\aspi;
prompt $P -$G
doskey
c:\aspi\mscdex /D:CDROM
```

The GDTX000.EXE driver is loaded from the first line following the HIMEM.SYS command of the CONFIG.SYS file. Loading the SETVER driver (part of MS-DOS) allows older versions of Microsoft's CDROM translation program MSCDEX (loaded from AUTOEXEC.BAT) to run trouble-free with the MS-DOS version currently installed. The next line loads the ICP ASPI Manager GDTASPI.EXE. Next, the ASPICD module for the CDROM drive is loaded. The parameter "/D:CDROM" has nothing to do with a drive name, it only serves as a recognition information for MSCDEX. As mentioned before, it is our objective to be able to access the CDROM drive with a drive name (i.e. E). Naturally, this drive name has to be "free", and there have to be enough drive names available. For example, the DOS command LASTDRIVE=H would enable the user to use drive names from A to H. In the AUTOEXEC.BAT file, the Microsoft translation program for CDROMs (MSCDEX - Microsoft CDROM Extension) is loaded. It is not part of MS-DOS (except for version 6). The parameter /D:CDROM set here has to be identical to the parameter set after the ASPICD module in the CONFIG.SYS file. After a warm reboot which serves to activate the changes made in the CONFIG.SYS and AUTOEXEC.BAT files, the CDROM drive can be accessed as drive E (in our example there are two SCSI hard disks in the PCI computer, and under MS-DOS they are accessed as C and D). Drive E can be accessed under Windows, too, now (the Icon next to "E" indicates that it is a CDROM drive).

D.5.2 Example: Using corelSCSI for the CDROM

When using the corelSCSI software, the installation is carried out by a program (*install*) so that the changes in the files CONFIG.SYS and AUTOEXEC.BAT mentioned below are, to a large extent, made automatically. Under corelSCSI the SCSI/FAST-SCSI channels of the ICP Controller are available as independent host adapters. The important lines in both files are printed bold.

CONFIG.SYS

```
device=c:\windows\himem.sys
device=gdtx000.exe
files=30
```



```

buffers=30
stacks=9,256
dos=high,umb
shell=\COMMAND.COM /E:512 /P
device=\dos\setver.exe
device=\gdt\gdtaspi.exe
device=c:\corel\cuni_asp.sys /ID:6 /HAN:0 /N:1 /D:MSCD000
lastdrive=h

```

AUTOEXEC.BAT

```

path=c:\;c:\dos;c:\gdt;c:\aspi;
c:\corel\corelcdx /M:8 /D:MSCD000

```

The first line following the HIMEM.SYS command of the CONFIG.SYS file loads the GDTX000.EXE. The next line loads the ICP ASPI Manager GDTASPI.EXE. Next, the corel ASPI Module for the CDROM drive is loaded. The parameter "/D:MSCD000" has nothing to do with a drive name, it only serves as recognition information for CORELCDX. As mentioned before, it is our objective to be able to access the CDROM drive with a drive name (i.e., E). Naturally, this drive name has to be "free", and there has to be enough drive names available. For example, the command LASTDRIVE=H would enable the user to use drive names from A to H under DOS. In the AUTOEXEC.BAT file, the corel translation program for CDROMs, CORELCDX, is loaded. The parameter /D:MSCD000 set here has to be identical to the parameter set after the ASPI Module in the CONFIG.SYS file. After a warm reboot which serves to activate the changes made in the CONFIG.SYS and AUTOEXEC.BAT files, the CDROM drive can be accessed as drive E (in our example there are two SCSI hard disks in the PCI computer, and under MS-DOS they are accessed as C and D). Drive E can be accessed under Windows, too, now (the Icon next to "E" indicates that it is a CDROM drive). Information on the various CDROM drives which can be used can be obtained directly from Corel.

D.6 The ICP ASPI Manager GDTASPI.EXE

The ICP ASPI Manager GDTASPI.EXE allows you not only to run *Not Direct Access Devices* (e.g., CDROMs, tapes, MODs etc.), but to control hard disks and removable hard disks, too (the so-called *Direct Access Devices*). These devices are then no longer controlled by ICPCON but exclusively by the ASPI interface. The advantage is evident, in particular with regard to removable hard disks. When using an appropriate ASPI module to access these removable hard disks, for example ASPIDISK.SYS or UNI_ASP.SYS from Corel, you can exchange the media of these drives under DOS without having to use ICPCON. To the ASPI interface, the ICP Controller appears as one host-adaptor. If there are more SCSI controllers (even if from various manufacturers) in the system and corresponding ASPI managers have been installed in the CONFIG.SYS file, you can determine a controller's host adapter number by using the ICP program **ASPISCAN.EXE**. In order to exclude that a *Direct Access Device* is run directly from the ICP Controller, it has to be reserved for the ASPI interface control. To do so, certain parameters have to be specified when the ICP ASPI manager is loaded:

DEVICE=GDTASPI.EXE /R:Hx1Iy1[:Hx2Iy2:Hx3Iy3 ...]

H:	host adapter number
I:	SCSI ID of the SCSI device to be reserved
x1, y1:	host adapter number, SCSI ID of the first SCSI device to be reserved (in decimal form)
x2, y2:	host adapter number, SCSI ID of the second SCSI device to be reserved (in decimal form)

Example: We assume that there is only one ICP Controller in the system. Two *direct access devices*, the removable hard disk connected to channel A, ID 2, and the hard disk connected to channel B, ID 4, have to be reserved for the ASPI manager. The corresponding entry in the CONFIG.SYS is:

```
DEVICE=GDTASPI.EXE /R:H0I2:H1I4
```

Important note: SCSI devices reserved for the ASPI manager must not have been initialized with ICPCON. Neither must they pertain to an ICP Logical or Host Drive. If necessary, these devices can be de-initialized with ICPCON.

As already mentioned in paragraph 6 of this chapter, in addition to the ASPI manager an ASPI module has to be present in order to be able to access the SCSI device under MS-DOS with a drive name (e.g., D, E, etc.). In the following description you find how to install ASPI interface-reserved *direct access devices* with the ASW ASPI module ASPIDISK.SYS and the corelSCSI ASPI module UNI_ASP.SYS.

D.6.1 Using ASW ASPIDISK.SYS

Step 1: Include GDTX0000.EXE, GDTASPI.EXE with appropriate reservations (./R:...), and ASPIDISK.SYS in the CONFIG.SYS file, then do a warm reboot (Ctrl+Alt+Del).

Step 2: Use the ASW program AFDISK.EXE to initialize the drive to be run through the ASPI interface.

Step 3: After the successful initialization, do a warm reboot (Ctrl+Alt+Del).

The CONFIG.SYS will be similar to the following (the relevant entries are printed bold):

```

device=gdtx000.exe
files=30
buffers=30
stacks=9,256
shell=\COMMAND.COM /E:512 /P
device=\gdt\gdtxdos.exe
device=\gdt\gdtaspi.exe /R:H1I4
device=aspidisk.sys

```

Note: Drives run with ASPIDISK.SYS are not compatible with drives run with ICPCON.

D.6.2 Using corelSCSI

Step 1: Include GDTX0000.EXE, GDTASPI.EXE with appropriate reservations (./R:...), in the CONFIG.SYS file, then do a warm reboot (Ctrl+Alt+Del).

Step 2: Load corel's *Install* program and follow the instructions. Preferably, use *Express-Setup*.

Step 3: After the successful installation, do a warm reboot (Ctrl+Alt+Del).

Step 4: Using the corelSCSI program CFORMAT, format the drive to be run through the ASPI interface.

The CONFIG.SYS will be similar to the file below (the relevant entries are printed bold). The parameters following the corelSCSI driver refer to a particular configuration, they have automatically been added by the corelSCSI INSTALL program.

```

device=gdtx000.exe
files=30
buffers=30
stacks=9,256
shell=\COMMAND.COM /E:512 /P
device=\gdt\gdtxdos.exe
device=\gdt\gdtaspi.exe /R:H1I4
device=\coreldrv\UNI_ASP.SYS /C:4 /ID:4;;;1 /VOL:1 /DOS4 /SS:512 /@4:-98

```

Note: Drives run with corelSCSI and the UNI_ASP.SYS driver are neither compatible with drives run with ICPCON and the ICP cache nor with those run with the above mentioned ASPIDISK.SYS driver.

D.7 Installing Windows 95

This guide will take you through the process to install the files necessary to allow the controller to operate under Windows 95.

We differentiate three cases: The ICP Controller is the primary controller, the ICP Controller is the secondary controller, and the ICP Controller is already installed under Windows 95 and its driver should be updated.

D.7.1 The ICP Controller is the primary controller

You must create an **MS-DOS partition** on and **format** the drive to which Windows 95 is to be installed. You also need a **CDROM** that is fully accessible under MS-DOS.

1. Transfer the WIN95 files from the **ICP System CDROM** to a 3.5" floppy disk. The files are located in the directory, (your CDROM drive letter):\DRIVERS\WIN95. You will need this disk later in the Windows 95 Setup.
2. Power-on the system. Press **Ctrl+G** to enter the **ICPCON** program.
3. Select the controller - **ENTER**. Press **F2** to enter **Advanced Setup**.
4. Highlight **Configure Controller** - **ENTER**. Highlight **Controller Settings** - **ENTER**.
5. Highlight **Delayed Write** - **ENTER**. Highlight **OFF** - **ENTER**. Delayed write is now disabled. This is done to ensure all files are written immediately to the Host Drive during the Windows installation.
6. Press **Esc**. A message appears: "Do you want to save changes?" Press **<Y>**.
7. Install Windows 95 per instructions provided with the program.
8. After installation: double click **My Computer** icon. Double click the **Control Panel** icon.
9. Double click the **System** icon. Click the **Device Manager** tab.
10. Double click **Other Devices**. Double click **PCI SCSI Bus Controller**.
11. Click **Driver**. Click **Change Driver**. Double click **SCSI Controllers**.
12. Click **Have Disk**. Insert the ICP Windows 95 driver disk you created in step 1.
13. Click **OK**. Click **OK** again. Click **OK** again.
14. Click **Cancel**. **Never click Test. Windows 95 is unable to determine if the ICP BIOS can be removed. Using the Test option may cause the system to freeze.**
15. **Remove** the ICP Windows 95 driver disk. Restart the system.

Upon completion of the Windows 95 installation you will need to load the ICPCON program to Windows 95. The following steps will take you through this process.

1. Find the ICPCON.EXE file in the DRIVERS\WIN95 directory on the ICP System CD.
2. Copy ICPCON.EXE to your Host Drive. Start the ICPCON program.
3. Press **ENTER** to select the Controller. Press **ENTER** to select the Protocol.
4. Press **ENTER** to select the Controller installed.
5. Highlight **View/Change Settings** and press **ENTER**.
6. Highlight **Cache Settings** and press **ENTER**.
7. Highlight **Delayed Write**. Use the space bar to toggle setting to **ON**.
8. Press **ENTER** two times. Delayed Write is now enabled.
9. Highlight **Save Information** and press **ENTER**.
10. Type the file name **ICP001** and press **ENTER**. *NOTE: This creates a "snapshot" of your system configuration. Anytime the configuration changes (i.e. add a new hard drive, hard drive failure, change system parameters, etc.) save the information again, using the ICP header for the file and the next higher number (i.e. ICP001, ICP002, ICP003, etc.). This information will be needed by ICP Technical Support personnel to assist you in troubleshooting problems with the controller.
11. Press **Esc** two times to exit the ICPCON program.

D.7.2 The ICP Controller is the secondary controller

1. Transfer the WIN95 files from the **ICP System CD** to a 3.5" floppy disk. The files are located in the directory, (your CDROM drive letter):\DRIVERS\WIN95. You will need this disk later in the Windows 95 Setup.
2. In Windows 95 double click on **My Computer** icon. Double click **Control Panel** icon.
3. Double click the **System** icon. Click the **Device Manager** tab.
4. Double click **Other Devices**. Double click **PCI SCSI Bus Controller**.
5. Click **Driver**. Click **Change Driver**. Double click **SCSI Controllers**.
6. Click **Have Disk**. Insert the ICP Windows 95 driver disk you created in step 1.
7. Click **OK**. Click **OK** again. Click **OK** again.
8. Click **Cancel**. **Never click Test. Windows 95 is unable to determine if the ICP BIOS can be removed. Using the Test option may cause the system to freeze.**
12. Remove the ICP Windows 95 driver disk. Restart the system.

D.7.3 Update the ICP Windows 95 Driver

1. Download the **WIN95.EXE** file from the ICP web site (<http://www.icp-vortex.com>). This self-extracting file contains all the Windows 95 files you need.

2. Run **WIN95.EXE** to get the update files.
3. Format a 3.5" HD disk (1.44MB). **Copy** all Windows 95 files to this disk.
4. In Windows 95 double click on **My Computer** icon. Double click **Control Panel**.
5. Double click **System** icon. Click **Device Manager** tab.
6. Double click **SCSI controller** icon. Double click the **ICP Controller** shown.
7. Click **Driver** tab. Click **Change Driver**.
8. Click **Have Disk**. Insert the Windows 95 driver disk created in step 3.
9. Click **OK** until you reach a prompt to specify the location of the update files.
10. Select the drive where the update disk is located. Click **OK**.
11. When file copy is done, remove the update disk and click Yes.
12. After installation of the new driver, the system needs to **reboot** before the new settings will take effect.

D.8 Installing Windows 98

The Mini Port Driver for Windows 95 which is delivered on the ICP System CDROM can be also used for Windows 98. If Windows 98 is installed via a CDROM which is connected with the ICP Controller, the following installation instructions have to be observed:

Step 1: Preparation of the installation

The "Delayed Write" function has to be switched off via the ICPCON program in the ROM of the ICP Controller. As soon as the Windows 95/98 driver of the ICP Controller is installed, this function can be switched on again. The driver checks whether the data in the cache of the controller is being written to the hard disks (so-called cache-flush).

Step 2: Installation via a hard disk partition.

It is recommended to transfer the installation data from the Windows 98 CDROM onto a hard disk partition beforehand. Therefore, the access to the CDROM connected with the ICP Controller has to be configured on the boot disk delivered with Windows 98. It is recommended to make a copy of the Windows 98 boot disk first and then to install the corresponding files from the ICP CDROM (see this chapter), in order to setup the access to the CDROM drive under DOS.

With this modified boot disk, a partition can be installed on the desired host drive (e.g., a single hard disk or a RAID array) of the ICP Controller. All data from the Win98 directory of the Windows 98 CD has to be transferred to a corresponding directory on the host drive by using the command "xcopy". In addition, the setup.exe file has to be copied from the root directory of the Windows 98 CD onto the host drive. If not yet available, it is now also time to generate an ICP Windows 95/98 driver disk from the ICP System CDROM.

The Windows 98 boot disk is modified once again by removing all drivers for the ICP Controllers. The Setup Program from Windows 98 can be started after booting from the boot disk in the previously created partition of the host drive.

The installation of Windows 98 can then be carried out in the usual way. After the installation has been carried out, the driver for the ICP Controller is installed (just as in Windows 95) via the device manager (also see this chapter).

Chapter E

Using NetWare

E. Using Novell NetWare

After having explained in chapters B and C the installation of the ICP Controller and the Host Drives, we would now like to give you some hints and pieces of advice on how to install Novell's operating system Novell NetWare. We shall mainly focus on NetWare 3.x, NetWare 4.x and NetWare 5. For successful installation, it is essential to study the NetWare system manuals thoroughly. The information given in this chapter refers to the loading of the ICP NetWare driver(s) only. The required ICP disks can be created from the ICP System CDROM.

E.1 Transparency of Host Drives

The structure of the Host Drives, which have been installed with ICPCON (in chapter C), is not known to NetWare. I.e., the operating system does not recognize that a given Host Drive consists of a number of hard disks forming a disk array. To NetWare, this Host Drive simply appears as one single hard disk with the capacity of the disk array. This complete transparency represents the easiest way to operate disk arrays under NetWare; neither NetWare nor the PCI computer need to be involved in the administration of these complex disk array configurations.

E.2 Novell NetWare 3.10, 3.11, 3.12 and 3.20

The ICP Controller and the Host Drives previously configured with ICPCON are integrated by means of the ICP driver software located on the ICP System CDROM. The driver belongs to the category of so-called NLMs (NetWare Loadable Module).

GDTRP310.DSK	for NetWare 3.10
GDTRP311.DSK	for NetWare 3.11
GDTRP312.DSK	for NetWare 3.12 and 3.20
ASPITRAN.DSK	ASPI manager
CTRLTRAN.DSK	Module for ICPCON

(Note: More information about the ICPCON diagnosis tool can be found in a separate chapter of this manual.). The installation of the fileserver itself is carried out following the Novell NetWare documentation. According to your NetWare version, copy the appropriate driver, the ICP ASPI Layer ASPITRAN.DSK and the ICP CTRLTRAN.DSK module to the boot disk or the DOS boot partition. During installation type in,

```
:LOAD GDTRP310 ENTER (NetWare 3.10)           or
:LOAD GDTRP311 ENTER (NetWare 3.11)           or
:LOAD GDTRP312 ENTER (NetWare 3.12, 3.20)
```

The ICP ASPI Manager ASPITRAN.DSK and the CTRLTRAN.DSK module will then be automatically loaded by the ICP NetWare driver (GDTRP310, GDTRP311 or GDTRP312). If more ICP Controllers are installed in the fileserver (i.e., for controller duplexing), the above mentioned driver has to be loaded several times. But as it is re-entrant, it is only loaded once. A single ICP Controller can be chosen by selecting its PCI slot number.

E.3 Novell NetWare 4.x – Using "DSK" Driver

The ICP Controller and the Host Drives previously configured with ICPCON are integrated by means of the ICP driver software located on the ICP System CDROM. The driver belongs to the category of the so-called NLMs (NetWare Loadable Module).

GDTRP400.DSK
 ASPITRAN.DSK
 CTRLTRAN.DSK

for NetWare 4.x
 ASPI manager
 Module for ICPCON

(Note: More information about the ICPCON diagnosis tool may be found in a separate chapter in this manual.)

if you wish to install NetWare 4.x from a CDROM, you first have to set up the CDROM drive under MS-DOS, following the instructions given in chapter D, section D.6. Then install NetWare following the instructions in the NetWare documentation. During the installation, the NetWare installation program asks you which hard disk driver you want to load, showing a list of available drivers. As the ICP driver is not part of this list yet, you have to boot it from the floppy disk: insert the ICP *Novell NetWare* disk into the floppy drive. Now, select the drivers GDTRP400, ASPITRAN and CTRLTRAN. Complete the installation according to the instructions given by the NetWare installation program.

Naturally you can also load the ICP driver directly from the system console, just as with NetWare 3.x:

```
:LOAD GDTRP400 ENTER
```

(ASPITRAN.DSK and CTRLTRAN.DSK will be loaded automatically). If more ICP Controllers are installed in the fileserver (i.e., for controller duplexing), the above mentioned driver has to be loaded several times. But as it is re-entrant, it is only loaded once. A single ICP Controller can be chosen by selecting its PCI slot number.

E.4 Novell NetWare 4.x/5.x – Using "HAM" Driver

ICP Controllers also support the HAM (Host Adapter Module) specification.

Before installing the ICP HAM driver make sure that your NetWare operating system is upgraded to the last level (Service Pack or Patches). To download the latest patches check the Novell website www.novell.com.

The ICP HAM driver for all ICP Controllers using Intel's i960Rx CPUs is (xy stand for the version number):

GDTRP1xy.HAM - the HAM driver
 GDTRP1xy.DDI - installation file for GDTRP1xy.HAM

This ICP HAM driver supports all NetWare versions where the latest NWPA (NetWare Peripheral Architecture) support modules are available and installed. (Note: there is a NWPA.EXE file on the ICP System CDROM which includes amongst others various CDMs - Custom Device Modules. Before you install these modules make sure that you do not overwrite already existing newer modules.)

Update a NetWare 4.x system from ICP DSK to ICP HAM driver support

To upgrade a pre-installed server from DSK- to HAM-drivers, the following steps should be carried out:

- Copy the file NWPA_411.EXE to the server start-directory and start it there. The file is self-extracting and can be deleted after use (see above note).
- Copy GDTRP1xy.HAM and CTRLTRAN.HAM into the server start-directory.

- Change all command lines in STARTUP.NCF and in AUTOEXEC.NCF from DSK to HAM. If CTRLTRAN.DSK is loaded directly, this command line must also be changed (CTRLTRAN.HAM). If the DSK driver is replaced by the HAM driver, the slot number parameter has to be changed as well.
- ASPITRAN.DSK is not required any more and can be deleted. NWPASPI.COM is used instead (part of NWPASPI.EXE). This ASPI driver has to be loaded if you want to use ASPI devices.

New Installation of NetWare 4.x with ICP HAM driver support

For a new installation with the ICP HAM driver the following steps are required:

- Create a temporary directory on the boot drive (e.g., C:\NWPASPI).
- Copy the file NWPASPI.EXE to the temporary directory C:\NWPASPI and start it there. The file is self-extracting and can be deleted after use (see note on previous side)
- Start the NetWare server installation.
- If the message "Install found the following hardware but was unable to find a matching driver" appears, switch to the file server console with (<ALT>-<Esc>).
- Type "SEARCH ADD 1 C:\NWPASPI" at the file server console.
- Type "LOAD C:\NWPASPI\NWPASPILOAD" at the file server console.
- Return to the installation screen (<ALT>-<Esc>).
- Press <RETURN> to get a list of all available drivers.
- Press <INSERT> to select additional drivers.
- Insert a prepared floppy disk with the ICP HAM driver (and DDI file) into the floppy drive and press <RETURN>. After reading the floppy disk information a new list appears.
- Select the ICP HAM driver now.
- The installation process asks now for the slot number of the ICP Controller. To determine this number, the following steps should be carried out:

Switch to the file server console with <Alt>-<ESC>.

Type "LOAD GDTRPIxy.HAM".

The driver now determines the slot number(s) and displays all slot numbers of all ICP Controllers. They should be written down.

Press <ESC> to stop the driver loading procedure.

Return to the installation screen (<ALT>-<Esc>).

- Now insert the slot number of the ICP Controller. If there are additional ICP Controllers in the system, load a driver for each of them with a unique slot number. Do not use the same slot number for more than one ICP Controller.

- Continue with the server installation.
- 'Down' and 'Exit' the server at the end of the installation.
- Copy all files except NWPA_411.EXE from the temporary directory to the start-directory of the server. The temporary directory can be deleted afterwards.

New installation of NetWare 5.x with ICP HAM driver

In order to install NetWare 5.x, we recommend to follow the standard installation procedure of the NetWare 5.x server.

E.5 Tips and Tricks

E.5.1 Optimize Data Throughput

High performance RAID controllers are designed for multi-I/O operations and are capable of processing several I/Os simultaneously. Especially cache controllers with powerful on-board RISC CPUs can handle many I/Os per second. NetWare offers the option of adjusting the number of write I/Os which are loaded on the mass storage subsystem. In order to gain optimum performance and speed from modern high performance disk controllers, the amount of the so-called 'maximum concurrent disk cache writes' has been increased with every further development of NetWare. Looking back to NetWare 3.11, only 100 'concurrent disk cache writes' were possible. With NetWare 4.10, this can be as much as 1000.

The number of concurrent disk cache writes delivering the best performance is highly dependent on the performance of the installed disk controller, the amount of cache RAM on the controller and the hard disks. The ICP Controllers can easily cope with up to 500 simultaneous requests. The following command line enables the adjustment of a new number under NetWare (default value = 50):

```
set maximum concurrent disk cache writes = xxxx
```

where xxxx represents the required number of concurrent disk cache writes.

E.5.2 'cache memory allocator out of available memory' in PCI-ISA Systems

PCI-Systems which are not equipped with an EISA-Bus behave in the same way as an ISA mainboard with regard to the available RAM memory. NetWare therefore does not automatically recognize the available memory above 16 MByte. The command 'Register Memory' allows the registration of memory above 16 MByte. Memory shortage can appear while loading several applications simultaneously on the server, especially where large volumes are concerned. This is because the Register Memory Command is normally carried out in the autoexec.ncf file. This is usually located in the SYS-Volume. An autoexec.ncf file placed in the DOS-Partition of the NetWare Server helps to get around this problem. In order to carry out this process, the disk driver has to be removed from the startup.ncf and inserted into the autoexec.ncf in the DOS partition. In this case, the disk driver has to be loaded directly after the Register Memory command. An example of an autoexec.ncf file:

```
register memory 1000000 1000000
LOAD C:GDTRP312
```

....

In addition, a further start file can be loaded on the SYS volume for differentiation, e.g., with the name 'autonet.ncf'.

E.5.3 Installing NetWare 4.1 - Wrong Drive Name

The following problem often occurs when installing NetWare 4.1 server: While copying the module `cdrom.nlm` the system hangs - forever. This problem only occurs when the CDROM drive's name under MS-DOS is 'cdrom', i.e., the `config.sys/autoexec.bat` contains the following files:

```
DEVICE=aspicd.sys /D:cdrom
and
mscdex /D:cdrom
```

To avoid this problem, simply change the CDROM's name in DOS to another name, i.e., use '/D:scsacd' instead of '/D:cdrom'.

E.5.4 NetWare-Server Not Stable When High Utilization

High server utilization, combined with a large number of applications running on the server often leads to the following problem: The number of 'Dirty Cache Buffers' increases tremendously and the server is then not stable. In order to avoid this situation, the following parameters should be modified:

1. Increase the number of concurrent disk cache writes for the disk subsystem:

```
set maximum concurrent disk cache writes
```

This parameter can be increased up to 500 for high performance controllers and fast hard disks.

2. Decrease the delayed write standard parameter:

```
set dirty disk cache delay time
```

This parameter sets the time whereafter 'dirty buffers' are written (flushed) from the cache of NetWare to the hard disk. The minimum value is 0.8 seconds which influences the server performance substantially. Therefore, care should be taken not to go below 0.8 seconds.

E.5.5 ICP Controller and Non-ASPI Compatible Controllers

If an ICP Controller is operated under NetWare together with a further controller / host adapter which does not support the ASPI standard, SCSI Raw Devices cannot be operated on both controllers (tapes, CDROMs).

In general, NetWare gives preference to controllers which support the ASPI Standard (e.g.: ICP, Adaptec). As soon as `ASPITRAN.DSK` is loaded (Auto-Loading Module) tapes and CDROMs on the ASPI non-compatible controller are no longer recognized.

To avoid this problem, the file `ASPITRAN.DSK` can be deactivated via a modification.

Please note: After this modification, no other Raw Devices (tapes, CDROMs) are recognized on the ICP (Adaptec,...).

In order to deactivate `ASPITRAN.DSK`, the string 'ASPI_Entry' has to be found by using a Disk-Monitor in `ASPITRAN.DSK` (please pay attention to capitals etc). This string is then modified, e.g., by replacing 'A' with an 'X' (i.e., 'XSPI_Entry').

This modified `ASPITRAN.DSK` enables the operation of Raw Devices on the non-ASPI-compatible Controllers.

E.5.6 Last Status Information

All ICP Controllers temporarily store the status information from all hard disks which are connected. This information can be very useful when searching for possible causes of disk failures or interferences. The last status information consists of a hexadecimal, 8 digit number and can be displayed via the ICPCON or can be saved in a SAVE INFORMATION ASCII file. The information is temporarily available in the ICP Controller's RAM. Therefore, it is important to check this information before switching off and before carrying out a Reset if a disk failure has occurred, or if interference was present. The last status information is divided into Controller-specific and SCSI-specific messages. A detailed description can be found in the files LASTSTAT.PDF (Adobe Acrobat format) or LASTSTAT.TXT (ASCII format) on the ICP vortex Website (<http://www.icp-vortex.com>).

E.5.7 Adding Additional Capacity After An Online Capacity Expansion

The additional capacity resulting from an online capacity expansion of an existing Array Drive is introduced to the system as a new Host Drive. In order to be able to make use of the new capacity without having to down the server, type "*scan for new devices*" on the server console to recognize the new capacity. Use *Install* to build new partitions and volumes.

E.6 Notes on ARCserve

Please make sure that you always have the latest version of your ARCserve software. The back-up program ARCserve can be used in connection with the ICP Controller. The communication between the tape device (for example DAT, DLT) and the ICP Controller takes place through the ASPI interface. For this purpose, the ICP ASPI Manager ASPITRAN.DSK is needed. When loading the regular ICP NetWare driver (for example GDTRP311.DSK), the ASPI Manager is automatically loaded, too. During the installation of ARCserve, choose **Adaptex ASPI Manager** as interface.



Chapter F

Using Windows NT
or
Windows 2000

F. Using Microsoft Windows NT or Windows 2000

After having explained the installation of the ICP Controller and the host drives in chapters B and C, we now explain how to install the operating systems Microsoft Windows NT and Windows 2000.

For a successful installation, we recommend that you take a close look at the manuals which came with your Windows NT/2000 package. The required ICP disks can be created from the ICP System CDROM.

F.1 Transparency of Host Drives

The structure of the Host Drives, which have been installed with ICPCON (in chapter C), is not known to Windows. I.e., the operating system does not recognize that a given Host Drive consists of a number of hard disks forming a disk array. To Windows, this Host Drive simply appears as one single hard disk with the capacity of the disk array. This complete transparency represents the easiest way to operate disk arrays under Windows; neither Windows nor the PCI computer need to be involved in the administration of these complex disk array configurations.

F.2 Windows NT

Your ICP Controller may be operated in all operating system variants, the Windows NT **Workstation** variant, the Windows NT **Small Business Server** variant and the Windows NT **Enterprise Edition** variant. The ICP Controller is integrated into the Windows NT operating system through the GDTX.SYS driver which is the same for all Windows NT variants.

For some ICP Controllers there is a special and optional firmware available (Cluster RAIDYNE®), which allows the setup and operation of **Microsoft Cluster Server** (MSCS). For further information on ICP clustering, check our website or contact us directly.

F.2.1 Preparing the Installation

The following steps have to be carried out and/or checked before you can begin with the installation of Windows NT.

Step 1 - Create an ICP Windows NT driver disk.

You need a 3.5" HD formatted floppy disk. Create from the ICP System CDROM the ICP Windows NT driver disk (you can copy file by file or write an image). If you copy file by file **do not use the Explorer**, because it may not copy all files from the ICP System CDROM. If you intend to install Windows NT 3.50 on your system, please observe the following: The ICP driver for NT 3.50 is located in the subdirectory DRIVERS of the ICP Windows NT driver disk. Its name is GDTX350.SYS. This file has to be renamed into GDTX.SYS and copied into the root-directory of the ICP Windows NT driver disk.

Step 2 – Disable the Delayed Write Cache of the ICP Controller.

When you do a warm boot by simultaneously pressing the CTRL+ALT+DEL keys, some PCI motherboards carry out a hard reset of the PCI bus. As a consequence, all expansion cards and devices that are connected to the PCI bus, including the ICP Controller, are reset. During the installation procedure of Windows NT this anomaly can cause the contents of the ICP cache RAM to be deleted before the data can be written to the disk(s). If this happens, the installation cannot be completed correctly. Such a warm boot automatically takes place after a FAT partition is converted into an NTFS partition at the end of the Windows NT installation procedure.

In order to avoid this problem and prevent the risk of data corruption, **the Delayed Write function of the ICP cache must be disabled during the complete installation.** To do so, use the ICPCON program, choose *Advanced Setup, Configure Controller, Controller Settings* and switch the *Delayed Write* function OFF. After having completed the Windows NT installation, switch the *Delayed Write* function ON again.

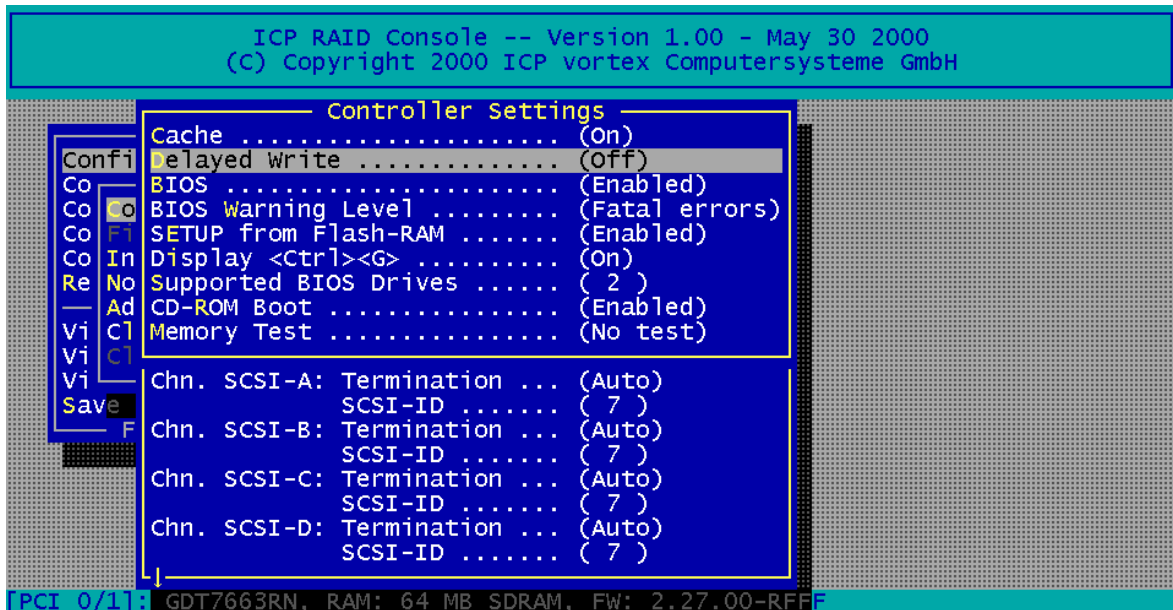

Step 3 – Check the Master Boot Record.

In some cases Windows NT checks the virtual geometric parameters (heads, sectors) of the ICP Controller BIOS Host Drives during the installation process. This can cause Windows NT to calculate wrong parameters. In this case, the first part of the installation procedure (text mode) seems to work fine, but after the first warm boot the installation terminates irregularly because the Windows NT boot loader is no longer available. To avoid this problem, we recommend that you re-create the so-called *master boot record* (MBR) of the given Host Drive. Therefore load in ICPCON the *Configure Host Drives* menu and then *Overwr. Master Boot Code*. **You should never use Overwr. Master Boot Code when the Host Drives already contain valid data.**

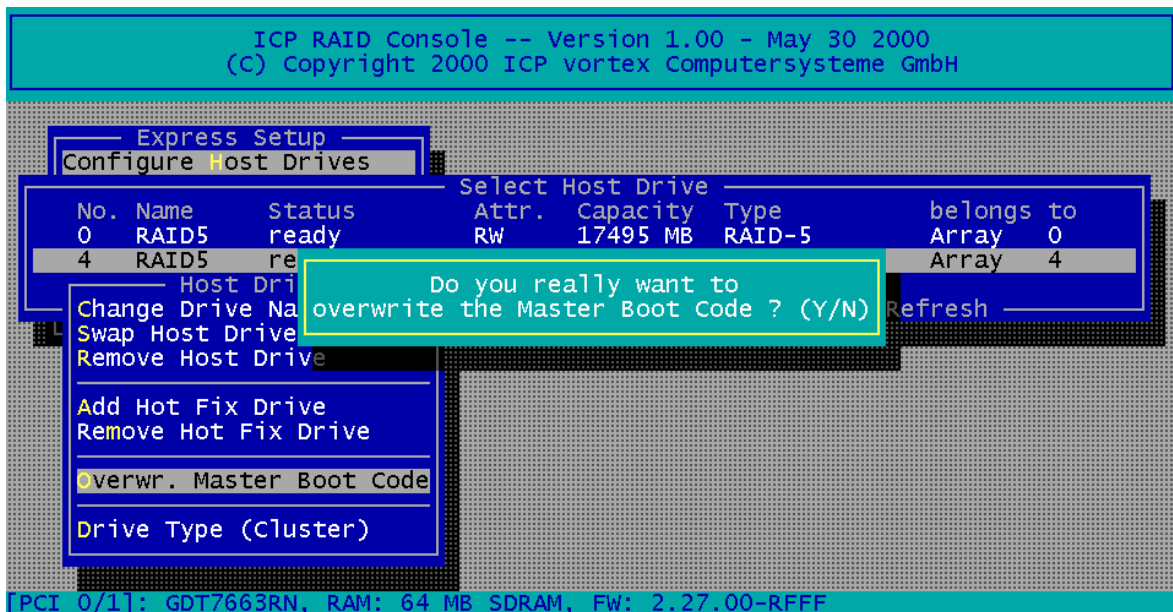

Step 4 – Enabling the CDROM Boot for a SCSI CDROM on the ICP Controller

(Note: This step is not necessary if you boot the Windows NT CD from a CDROM which is not controlled by the ICP Controller).

Load ICPCON and press F4 for the Advanced Setup Mode. Select the *Configure Controller* menu and enable the CDROM-Boot.

F.2.2 The Installation

First of all, make sure that you have verified or carried out all steps described in section F.2.1.

F.2.2.1 The ICP Controller is the first Controller in the System

The following instructions 1.) to 7.) assume that the ICP Controller is the first controller in the system and that the operating system is booted from its first Host Drive.

We recommend you to install Windows NT through booting the Windows NT CD and not using the floppy disks.

1. Boot the Windows NT CD.
2. After the setup screens comes up press **F6**
3. Select: **S=Specify Additional Device** and **Other**
4. Insert the ICP Windows NT driver disk.
5. Select the **ICP GDT Disk Array Controller** and press ENTER.
6. Continue with the Installation and follow the Windows NT Setup program. **Note: The NT boot partition size is limited (by NT itself) to max. 4096MB.**
7. After successful installation, enable the Delayed Write function of the ICP Controller again (using ICP RAID Console or ICP RAID Navigator)

F.2.2.2 The ICP Controller is the Secondary Controller in the System

If you wish to use the ICP Controller as a secondary controller in your Windows NT system (e.g. Windows NT is installed on an IDE hard disk), follow the instructions a.) to h.) below:

- a) Double click the **My Computer** icon.
- b) Double click **Control Panel**.
- c) Double click **SCSI Adapters..**
- d) Click on **Drivers**.
- e) Click on **Add**.
- f) Click on **Have Disk**.
- g) Insert the ICP Windows NT driver disk and click **OK**.
- h) Select **GDT SCSI Disk Array Controller**.

At the next system boot the ICP driver is loaded and the existing Host Drives are ready to be partitioned under Windows NT.

F.2.3 Using the Hot Plug Function with RAID Host Drives

In order to be able to use the Hot Plug function under Windows NT, you may either use ICP RAID Console or ICP RAID Navigator.

F.2.4 Installation of a new GDTX.SYS Driver Version

If it should become necessary to install a new version of the GDTX.SYS driver, the procedure is as follows:

- a) Double click the **My Computer** icon.
- b) Double click **Control Panel**.
- c) Double click **SCSI Adapters**.
- d) Click on **Drivers**.
- e) Select **GDT SCSI Disk Array Controller**.
- f) Click on **Add**.
- g) Click on **OK**.
Windows NT informs you that this driver is already on the system and asks if you want to use the currently installed driver or a new one.
- h) Click on **New** and insert the ICP Windows NT driver disk.
- i) Click on **Continue** and NT copies the new driver to the disk.

At the next system boot the ICP driver is loaded.

F.2.5 Installation of a Removable Hard Disk

Removable hard disks (e.g., SyQuest, IOMEGA or magneto optical devices, MODs) are controlled by the ICP Controller in two fundamentally different modes:

Mode 1: The removable hard disk is treated like a normal hard disk. The data passes through the cache of the ICP Controller and the media needs to be initialized with ICPCON.

Mode 2: The removable hard disk is handled as a *Raw Device*. This means that the removable device is directly controlled by Windows NT without any further interaction of the controller. Consequently, the data is not cached by the ICP cache and the media does not need to be initialized with ICPCON. The advantage of mode 1 lies in a decisively better performance due to caching. On the other hand, the relatively complicated procedure of media changing presents a disadvantage. The opposite is true when adopting mode 2: The media change is easy and the media are compatible with other disk controllers (e.g., NCR). The performance is rather low since the data cannot be cached on the ICP Controller. To install a removable hard disk as a Raw Device, the media must not be initialized with ICPCON and the device must be set to a SCSI-ID equal to or greater than 2. In addition, the parameters of the ICP driver GDTX.SYS need to be configured differently in the Windows NT *Registry*

HKEY_LOCAL_MACHINE\SYSTEM\CurrentControlSet\Services\gdtx\Parameters\Device

To do so, follow these instructions:

1. Load the Registry Editor **regedt32.exe** in **\...\system32**
2. Select the window **HKEY_LOCAL_MACHINE on Local Machine**
3. Choose the Key **gdtx** in the directory **SYSTEM\CurrentControlSet\Services** .
4. Enter by means of Edit, function Add Key, the name **Parameters** .
Select **Parameters** .
5. Enter by means of Edit, function Add Key, the name **Device** .
Select **Device** .
6. Enter by means of Edit, function Add Value, the name **DriverParameter** .
7. Use data type **REG_SZ**.
Now enter the parameter string (e.g.): **/reserve:0,0,4,0** .
(This string causes the SCSI device connected with ICP Controller 0, SCSI channel 0, SCSI ID 4, LUN 0 to be reserved as a Raw Device. ICP Controller 0 is the ICP Controller which is detected and configured first after switching on your computer system).
8. The reservation of the SCSI device becomes active after completing regedt32, exiting and rebooting the system.

Note: This reservation can also be carried out within the ICPService in the Control Panel. Double-click on the ICPService icon. Here is a field "Driver", where you can also add the above mentioned string.

F.2.6 Adding Additional Capacity After An Online Capacity Expansion

The additional capacity resulting from an online capacity expansion of an existing Array Drive is introduced to the system as a new Host Drive. In order to be able to make use of the new capacity without having to down the server, use the *Disk Administrator*. When loading, it detects the new Host Drive.

F.2.7 Update Windows NT -> Windows 2000

For an update from Windows NT -> Windows 2000 it is very important that you load under NT the current ICP driver (gdtx.sys) BEFORE you update Windows NT -> Windows 2000. Otherwise the update procedure may hang or fail.

F.3 Windows 2000

Your ICP Controller may be operated in **Windows 2000 Professional**, **Windows 2000 Server** and **Windows 2000 Advanced Server**. The ICP Controller is integrated into the Windows 2000 operating system through the GDTX.SYS driver which is the same for both Windows 2000 variants

For some ICP Controllers there is a special and optional firmware available (Cluster RAIDYNE®), which allows the setup and operation of **Microsoft Cluster Server** (MSCS). For further information on ICP clustering, check our website or contact us directly.

F.3.1 Preparing the Installation

The following steps have to be carried out and/or checked before you can begin with the installation of Windows 2000.

Step 1 - Create an ICP Windows 2000 driver disk.

You need a 3.5" HD formatted floppy disk. Create from the ICP System CDROM the ICP Windows 2000 driver disk (you can copy file by file or write an image). If you copy file by file **do not use the Explorer**, because it may not copy all files from the ICP System CDROM.

Note: You cannot use the ICP Windows NT driver disk for installing Windows 2000.

Step 2 – Enabling the CDROM Boot for a SCSI CDROM on the ICP Controller

(Note: This step is not necessary if you boot the Windows 2000 CD from a CDROM which is not controlled by the ICP Controller).

Load ICPCON and press F4 for the Advanced Setup Mode. Select the *Configure Controller* menu and enable the CDROM-Boot.

F.3.2 The Installation

First of all, make sure that you have verified or carried out all steps described in section F.3.1.

F.3.2.1 The ICP Controller is the first Controller in the System

The following instructions 1.) to 6.) assume that the ICP Controller is the first controller in the system and that the operating system is booted from its first Host Drive.

We recommend you to install Windows 2000 through booting the Windows 2000 CD and not using the floppy disks.

1. Boot the Windows 2000 CD.
2. After the setup screens comes up press **F6**
3. Select: **S=Specify Additional Device**
4. Insert the ICP Windows 2000 driver disk.
5. Select the **ICP GDT Disk Array Controller** and press ENTER.
6. Continue with the Installation and follow the Windows 2000 Setup program.

F.3.2.2 The ICP Controller is the second Controller in the System

To install an ICP Controller in an already running Windows 2000 system, you may either follow the instructions of the installation wizard, who has detected the ICP Controller during the boot process, or use the Control Panel.



Chapter G

Using LINUX

G. Using LINUX

After having explained the installation of the ICP Controller and the host drives in chapters B and C, we now explain how to install the operating system LINUX. For a successful installation, we recommend that you take a close look at the manuals which came with your LINUX distribution package. We have tested LINUX from: Caldera, Debian, DLD, LST, Red-Hat and S.u.S.E. . If you require an ICP Linux disk, this can be created from the ICP System CDROM.

G.1 Transparency of Host Drives

The structure of the Host Drives, which have been installed with ICPCON (in chapter C), is not known to LINUX. I.e., the operating system does not recognize that a given Host Drive consists of a number of hard disks forming a disk array. To LINUX, this Host Drive simply appears as one single hard disk with the capacity of the disk array. This complete transparency represents the easiest way to operate disk arrays under LINUX; neither LINUX nor the PCI computer need to be involved in the administration of these complex disk array configurations.

G.2 Available Drivers and Tools

gdth.tgz	ICP driver sources for intel and alpha systems
icpcon.tgz	ICPCON and object files (intel)
icpcona.tgz	ICPCON and object files (alpha)

The following ICP drivers are part of the various Kernel versions:

from Kernel 2.0.31	ICP driver 1.00
from Kernel 2.0.35/2.1.63	ICP driver 1.02
from Kernel 2.0.36	ICP driver 1.07
from Kernel 2.2.0 (pre7)	ICP driver 1.10

G.3 Updating the driver using the driver sources

- Copy the driver sources to /usr/src/linux/drivers/scsi (for a DOS disk for example with 'mcopy a:gdth.tgz')
- Unpack the archive with 'tar xvfz gdth.tgz'
- Compile a new Kernel (procedure depends on the Linux distribution, 'make config', 'make dep', 'make clean' may become necessary before)

G.4 Driver installation or update using a patch

New installation of a driver patch:

- Copy the corresponding patch on the Linux system (preferably to /usr/src/linux e.g. gdtp2036.gz for Linux 2.0.36)

- b) Carry out the patch, e.g. for Linux 2.0.36:
`cd /usr/src/linux`
`zcat gdtp2036.gz | patch -p1 2>log_file`
 Thereafter check the file `log_file` for possible errors
- c) Configure the Kernel / Enter the ICP Controller with:
`cd /usr/src/linux`
`make config`
- d) Check dependencies / Compile Kernel:
 see LINUX manual (e.g. `make dep && make zlilo`)
- e) Reboot system

Update of a driver patch:

- a) Copy the new patch to `/usr/src/linux`
- b) Remove old patch with
`zcat old_patch.gz | patch -p1 -R`
`rm drivers/scsi/gdth*`
 (gdth sources with versions older than 1.01 have to be removed with `rm` manually. With newer versions this is no longer necessary.)
- c) Carry out the patch
`zcat new_patch.gz | patch -p1 2>log_file`
- d) Compile a new Kernel
- e) Reboot the system

G.5 ICPCON – Configuration and Monitoring Tool

Detailed information on ICPCON can be found in a separate chapter of this User's Manual.

The ICP System CDROM includes two archives:

<code>icpcon.tgz</code>	ICPCON and object files (intel)
<code>icpcona.tgz</code>	ICPCON and object files (alpha)

These archives include all object files to create ICPCON, as well as an executable ICPCON compiled on a current Linux version. If you encounter problems with this executable ICPCON, you can easily compile a new ICPCON on your own Linux system:

unpack the tgz-file:	<code>tar xvfz icpcon.tgz'</code>
compile ICPCON:	<code>make'</code>
start ICPCON:	<code>'./icpcon'</code>

In order to be able to compile ICPCON you need the C-compiler and the Kernel sources on your system. The link `/usr/src/linux` has to point to the Kernel sources which correspond with the currently booted Kernel of your system. This is important for "signature.c" to use the right magic for the communication with the driver. Otherwise it may happen that you get "Wrong signature" when trying to start ICPCON. ICPCON is loaded by entering:

`icpcon ENTER`

G.6 *gdth driver parameters*

Driver versions older than 1.05 do not support driver parameters. From driver version 1.05 to 1.07 it is necessary to add driver parameters directly in /usr/src/linux/drivers/scsi/gdth.c . From version 1.10 on you may use for the parameters the LILO boot prompt (gdth=...) or in /etc/lilo.conf the append command (append = "gdth=...").

Reservation of SCSI devices:

The reservation of SCSI devices becomes necessary if you wish that so-called 'Direct Access Devices' (e.g. hard disks, removable hard disks like IOMEGA or SyQuest, some MOs) are directly controlled by Linux and not the ICP Controller's firmware (i.e., they are not configured as Host Drives). This is also called "raw-service". In this case the ICP Controller does not cache the data to/from the reserved SCSI device. This reservation is important for removable hard disks. If they are controlled by the ICP Controller and are a Host Drive, a media change is very difficult. 'Non Direct Access Devices' like CD-ROMs, Streamers, DATs, etc. do not require a reservation. IMPORTANT: The reservation is only possible with not-initialized SCSI devices. (Use ICPCON to de-initialize an already initialized device).

As already mentioned a reservation for driver versions 1.05 to 1.07 has to be made directly in the driver sources. Look for 'gdth_reserve_str' in '/usr/src/linux/drivers/scsi/gdth.c' . You'll find a non-active sample entry, which you can change according to the coordinates of the device you want to reserve (enter Adapter, Bus, ID and LUN). Save the file and compile a new kernel.

From driver version 1.10 on you can add the parameters for the reservation with the LILO append command:

Excerpt of /etc/lilo.conf:

```
# End LILO global section
# Linux bootable partition config begins
image = /boot/vmlinuz
root = /dev/sda2
label = Linux
append = "gdth=reserve_list:1,0,6,0"
# Linux bootable partition config ends
```

This gdth driver parameter reserves the SCSI device which is connected with ICP Controller 1 (second ICP Controller), SCSI Bus 0 (channel A), ID 6, LUN 0 for Linux (raw service).

After each change in /etc/lilo.conf , lilo must be loaded once.

Driver parameters may also be entered at the LILO boot prompt. (e.g.: gdth=reserve_list:1,0,6,0).

Further driver parameters:

irq1,irq2, etc.	Only for ICP EISA Controllers with disabled BIOS (irq1, irq2, etc. correspond with the IRQs of the ICP Controllers)
disable:Y	deactivates the ICP driver
disable:N	activates the ICP driver
reserve_mode:0	reserves no SCSI devices [*1]
reserve_mode:1	reserves all not-initialized removable hard disk [*1]
reserve_mode:2	reserves all not-initialized SCSI devices [*1]
reserve_list:h,b,t,l,h,b,t,l,	reserves SCSI devices at the corresponding coordinates with h=Hostadapter, b=SCSI Bus, t=Target ID, l=LUN
reverse_scan:Y	reversed scanning order of the PCI controllers
reverse_scan:N	normal scanning order of PCI Controllers according to the system BIOS
max_ids:x	x = number of target IDs per SCSI channel (accelerates the boot process)
rescan:Y	rescan all SCSI channels / IDs
rescan:N	scan only those SCSI devices found during system power up [*1]

[*1] The driver parameters reserve_mode and rescan:N require ICP Controllers with firmware version FW 1.23.00/2.23.00 or higher.

The current default settings of the driver are:

```
"gdth=disable:N,reserve_mode:1,reverse_scan:N,max_ids:127,rescan:N"
```

If gdth is loaded as a module, these parameters can also be added with a special syntax. IRQ parameters are entered as 'IRQ=' (e.g. IRQ=10). Several parameters are not separated with a comma (',') but a space (' '). All ':' are substituted with '=', all 'Y' with '1' and all 'N' with '0'.

```
Default: "modprobe gdth disable=0 reserve_mode=1 reverse_scan=0
max_ids=127 rescan=0"
```

G.7 Notes

Further interesting information:

/proc-Support:

Read of /proc/scsi/gdth/0, /proc/scsi/gdth/1, .. :

Displays the ICP Controller/SCSI busses, firmware version, driver version (e.g.: cat /proc/scsi/gdth/0)

Write to /proc/scsi/gdth/0, .. :

gdth flush	Flush all Host Drives of the ICP Controller
gdth flush drive	Flush the Host Drive with the number drive
gdth wbp_off	Disable Write-Back permanently
gdth wbp_on	Enable Write-Back permanently
gdth wb_off	Disable Write-Back for this session (from Firmware version 1.15/2.15)
gdth wb_on	Enable Write-Back for this session (from Firmware version 1.15/2.15)

LINUX IS GREAT !



Chapter H

Using SCO UNIX

H. Using SCO UNIX V/386

After having explained in chapters B and C the installation of the ICP Controller as well as that of the Host Drives, we would now like to give you a few hints regarding the installation of the operating systems

SCO UNIX V/386 3.2v4.x, 3.2v5.x (Open Server)

For a successful installation, it is essential to read the SCO system manuals thoroughly. The required ICP disks can be created from the ICP System CDROM.

H.1 Transparency of Host Drives

The structure of the Host Drives, which have been installed with ICPCON (in chapter C), is not known to UNIX. I.e., the operating system does not recognize that a given Host Drive consists of a number of hard disks forming a disk array. To UNIX this Host Drive simply appears as one single hard disk with the capacity of the disk array. This complete transparency represents the easiest way to operate disk arrays under UNIX; neither UNIX nor the PCI computer need to be involved in the administration of these complex disk array configurations.

H.2 General Tips for Installation

In the following description, we shall explain the installation of SCO UNIX V/386 3.2v4.x and 3.2v5.x step by step in combination with the ICP Controller. Apart from the SCO UNIX floppy disks and the SCO UNIX documentation, you also need the ICP floppy disks (they can be created from the ICP System CDROM):

GDT SCO UNIX BTLD-Disks for 3.2v4.x, 3.2v5.x

for the installation. In the following discussion, when we speak of a *boot drive* we refer to the drive which is first integrated upon system power up. For the ICP Controller this drive is the first Host Drive in the list of ICP Host Drives, i. e., the Host Drive number 0 (see ICPCON menu *Configure Host-Drives*). During the installation you will have to decide whether you want the ICP Controller to make the boot drive available, or whether you want to operate the ICP Controller as an additional controller in the computer system.

If the ICP Controller is the only hard disk controller in the computer system, it will automatically make the boot drive available. If there are more hard disk controllers, the controller which makes the first drive available (the drive containing the MS-DOS partition C:) will be the boot controller.

In principle, SCO UNIX is always installed on the hard disk with Target ID 0 and LUN 0 on host adapter 0, that is on Host Drive 0 of this controller. If SCO UNIX is installed from tape (streamer) the streamer must have SCSI ID 2 and be connected with SCSI channel A of host adapter 0. For an installation from CD-ROM, the CD-ROM device must have SCSI-ID 5 and has to be connected with channel A of the ICP Controller.

When using 3.2v4.x or 3.2v5.x, you have the option to link the driver to the kernel before starting the kernel (*btld* (ADM)). This will allow you to use the ICP Controller as the only controller in the system. Use the ICP BTLD Disk. During the installation, whenever the N1 floppy disk is inserted and the message

Boot

:

is displayed, do not press ENTER immediately, but type in *link* ENTER. The system will then prompt you for the name of the BTLD driver. Now type in *gdth*. It may be necessary to type in the complete boot string. In this case, you have to add the following command:

```
link=gdth btld=fd(xx)
```

where *xx* is the "Minor Device Number" of the corresponding device file. *xx* = 60 for fd0135ds18, 3,5" floppy as A,: or *xx* = 61 for fd1135ds18, 3,5" floppy as B: (see SCO UNIX system Administrator's Reference, Hardware Dependence, floppy devices). When requested, enter the IRQ which has been assigned to the PCI INT of the ICP Controller (see chapter B, Hardware Installation). In addition, the ICP BIOS must not be disabled and the boot drive must be connected with the ICP Controller having the lowest PCI slot number. When the UNIX installation has been completed, the driver is installed, too, and you may install further devices with *mkdev hd* (ADM).

If the ICP Controller is an additional controller, the installation of the driver is carried out with *installpkg*.

H.3 Instructions on *mkdev* (ADM) for 3.2v4.x

Whenever the program *mkdev hd* (ADM) is started, you will be asked for the coordinates of the device you wish to install. The driver does not automatically display all devices connected, so after the installation you will find a tool named **GDTSCAN** in the directory '/etc'. The scanning can take up to several seconds, especially when there is more than one controller in the system. The devices are displayed together with their host adapter number, target-ID and LUN. These values are to be used in *mkdev* (ADM). Let's have a brief look at how the HA-no., target-ID and LUN are determined. Please note that the UNIX driver always maps the first detected Host Drive with target-ID 0, LUN 0. Exactly this drive would be used as a boot drive when the ICP Controller is to make the boot drive available.

Host adapter Number (HA)

The host adapter number assigned to the ICP Controller is derived from the PCI slot number of the ICP Controller. Therefore, if there is only one ICP Controller installed in the PCI bus computer system, the host adapter number=0. If there are two ICP Controllers installed, the ICP Controller with the lower PCI Slot number is assigned host adapter number 0 and the ICP Controller with the higher PCI slot number is assigned host adapter 1. (Note: After a cold boot, the ICP BIOS displays a couple of messages, each beginning with the controller's PCI slot number, e.g. "[PCI 0/3] 4 MB RAM detected". The number after the '/' is the slot number of the controller. This helps you to determine which is the order of the ICP Controllers and which host adapter number is assigned to them by UNIX. See also chapter B, Hardware Installation).

UNIX Target-ID and LUN

Target-IDs 0 and 1 with LUN 0 to 7 are reserved for "**Direct Access Devices**" (devices behaving like a hard disk or a removable hard and therefore configurable with ICPCON). There is a correlation between the Host Drive number ICPCON assigns (menu *Configure Host Drives*), and the assigned target-ID and LUN:

$$\text{Host-Drive Number} = 8 * \text{Target-ID} + \text{LUN}$$

The Host Drive number is the number the drive is given in the list of available Host Drives in the ICPCON program. The following exemplary screen shows a list of Host Drives. In this example, there are two Host Drives installed.

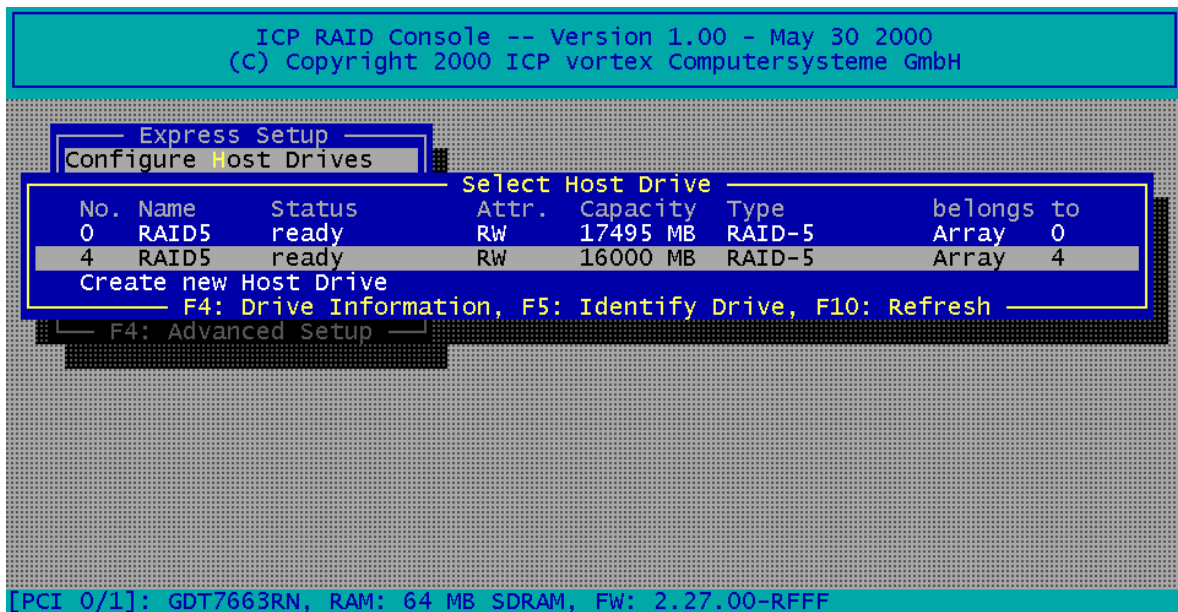

Therefore, the first Host Drive has target-ID 0 / LUN 0 and the second target-ID 0 / LUN 1. The formula for determining target ID and LUN from the existing Host Drive numbers yields the following possible combinations for "Direct Access Devices":

Host Drive number	Target ID	LUN	Host Drive number	Target ID	LUN
0	0	0	8	1	0
1	0	1	9	1	1
2	0	2	10	1	2
3	0	3	11	1	3
4	0	4	12	1	4
5	0	5	13	1	5
6	0	6	14	1	6
7	0	7	15	1	7

This conversion is necessary because the single SCSI devices are not declared to the host operating system in the order of their SCSI-IDs anymore, but according to the Host Drive numbers they have in ICPCON. Host Drives are a prerequisite for the ICP Controller to be able to link several SCSI devices to form a higher structure (i.e., RAID 5).

The sequence of the single Host Drives can be changed very easily by having ICPCON sort them in its *Configure Host Drives* menu. In this way, it is also possible to change the boot drive (it had previously been selected as boot drive because it has the lowest drive number, that is, 0, and is therefore the first drive to be communicated to the system).

Target ID and LUN of "**Not Direct Access Devices**" (devices such as streamers, tapes, CD-ROMS, etc., not configurable with ICPCON) are determined on the basis of the SCSI-ID and the SCSI channel used by the ICP Controller. These devices can only be configured with SCSI-IDs 2 to 6. SCSI-ID 0 and 1 are reserved for hard disks, SCSI-ID 7 for the ICP Controller. If "Not Direct Access Devices" are configured on SCSI-ID 0 or 1, they are not recognized during the scanning process and can therefore not be used. The Target IDs of *Not Direct Access Devices* are identical to their SCSI-ID, the LUN depends on the SCSI channel used (LUN 0 for SCSI channel A and LUN 4 for SCSI channel B). Note: After a cold boot the ICP BIOS displays all connected devices with their physical coordinates, i. e. their SCSI-ID and SCSI-LUN, (see "Chapter B, ICP Controller Function Check").

SCSI-ID of Not Direct Access Devices	Used ICP SCSI channel	UNIX Target ID	UNIX LUN
2	A	2	0
3	A	3	0
4	A	4	0
5	A	5	0
6	A	6	0
2	B	2	4
3	B	3	4
4	B	4	4
5	B	5	4
6	B	6	4

Having to determine the Target ID and LUN in such a complicated manner might seem rather awkward. However, it is necessary to do so because the ICP Controllers have more than one SCSI channel, whereas UNIX can only manage host adapters with one SCSI channel. Therefore, the ICP UNIX driver has to make the appropriate transformations.

Configuration Example:

In the PCI computer are two ICP Controllers (HA 0 = 1st ICP, HA 1 = 2nd ICP), each with two SCSI channels.

1 hard disk	as Host Drive no. 0 on HA0
1 hard disk	as Host Drive no. 0 on HA1
1 hard disk	as Host Drive no. 1 on HA1
1 Streamer	SCSI-ID 2, LUN 0 on SCSI channel A of HA0
1 CD-ROM	SCSI-ID 3, LUN 0 on SCSI channel A of HA0
1 DAT	SCSI-ID 2, LUN 0 on SCSI channel B of HA1

Result:

HA	Target-ID	LUN	Device
0	0	0	1 st hard disk, Host Drive no. 0 (boot- and installation drive)
0	2	0	Streamer
0	3	0	CD-ROM
1	0	0	hard disk, Host Drive no. 0
1	0	1	hard disk, Host Drive no. 1
1	2	4	DAT

H.4 Instructions on *mkdev* (ADM) for 3.2v5.x (Open Server)

Whenever the program *mkdev hd* (ADM) is started, you will be asked for the coordinates of the device you wish to install. The driver does not automatically display all devices connected, so after the installation you will find a tool named **GDTSCAN** in the directory '/etc'. The scanning can take up to several seconds, especially when there is more than one controller in the system. The devices are displayed together with their host adapter number, target-ID and LUN. These values are to be used in *mkdev* (ADM). Let's have a brief look at how the HA-no., target-ID and LUN are determined. Please note that the UNIX driver always maps the first detected Host Drive with target-ID 0, LUN 0. Exactly this drive would be used as a boot drive when the ICP Controller is to make the boot drive available. As an alternative for the following "new" mapping method of SCO UNIX V/386 3.2v5.x, you may also use the mapping as described in section H.3 (for 3.2v2.0 & 3.2v4.x). To enable this ("old") mapping, change in the

```
/etc/conf/pack.d/gdth/space.c
gdth_mapping=1           into
gdth_mapping=0
```

Host adapter Number (HA)

The host adapter number assigned to the ICP Controller is derived from the PCI slot number of the ICP Controller. Therefore, if there is only one ICP Controller installed in the PCI bus computer system, the host adapter number=0. If there are two ICP Controllers installed, the ICP Controller with the lower PCI Slot number is assigned host adapter number 0 and the ICP Controller with the higher PCI slot number is assigned host adapter 1. (Note: After a cold boot, the ICP BIOS displays a couple of messages, each beginning with the controller's PCI slot number, e.g. "[PCI 0/3] 4 MB RAM detected". The number after the '/' is the slot number of the controller. This helps you to determine which is the order of the ICP Controllers and which host adapter number is assigned to them by UNIX. See also chapter B, Hardware Installation).

UNIX Target-ID and LUN

Target-IDs and LUNs for "Not Direct Access Devices" (devices like streamers, tapes and CD-ROMs and therefore not configurable via ICPCON), are directly assigned to the SCSI-ID and the channel of the ICP Controller. Host Drives are assigned in increasing order to the free coordinates (bus number and target ID;LUN is always 0).

Configuration Example:

In the PCI computer are two ICP Controllers (HA 0 = 1st ICP, HA 1 = 2nd ICP), each with two SCSI channels.

1 hard disk	as Host Drive no. 0 on HA0
1 hard disk	as Host Drive no. 0 on HA1
1 hard disk	as Host Drive no. 1 on HA1
1 Streamer	SCSI-ID 2, LUN 0 on SCSI channel A of HA0
1 CD-ROM	SCSI-ID 3, LUN 0 on SCSI channel B of HA0
1 DAT	SCSI-ID 2, LUN 0 on SCSI channel A of HA1

Result:

HA	Bus	Target-ID	LUN	Device
0	0	0	0	1 st hard disk, Host Drive no. 0 (boot drive)
0	0	2	0	Streamer
0	1	3	0	CD-ROM
1	0	0	0	hard disk, Host Drive no. 0
1	0	1	0	hard disk, Host Drive no. 1
1	0	2	0	DAT
1	0	3	0	hard disk, Host Drive no.2

Important Note: 'Not Direct Access Devices' must not be connected to Bus 0, Target-ID 0, LUN 0. This is reserved for the boot device under SCO Unix 3.2V5.0

H.5 Further Information

- From version 4.x of SCO UNIX V/386 3.2, a media change can be made with the UNIX commands **MOUNT** and **UNMOUNT**. Please make sure that the removable hard disk keeps its ICPCON drive number when changing the media, otherwise a separate ID/LUN entry is necessary for each single media (since the drive number depends on the media and not the device containing it).
- SCO UNIX V/386 3.2v4.x and later versions support a maximum of 4 ICP Controllers in one computer system.
- The tool **GDTSYNC** in the directory '/etc' carries out a UNIX SYNC command (update super block) and causes all buffers still present in ICP's cache to be written to the Logical Drives. It is advisable to use this tool before shutting down the system.
- When using *Direct Access Devices* with **exchangeable media** (e.g., removable hard disks), a media has to be inserted when the system is booted, otherwise the device is not available under UNIX.
- "Not Direct Access Devices" (streamer, tapes, CD-ROMs, etc) can be switched on even after system power up, they will still be recognised by **GDTSKAN** afterwards.



Chapter I

Using UnixWare

I. Using UnixWare

After having exposed the installation of the ICP Controller as well as that of the Host Drives in chapters B and C, we would now like to give you some hints and pieces of advice on how to install the operating system UnixWare version 2.x and UnixWare 7. The required ICP disk can be created from the ICP System CDROM.

I.1 Transparency of Host Drives

The structure of the Host Drives, which have been installed with ICPCON (in chapter C), is not known to UNIX. I.e., the operating system does not recognize that a given Host Drive consists of a number of hard disks forming a disk array. To UNIX, this Host Drive simply appears as one single hard disk with the capacity of the disk array. This complete transparency represents the easiest way to operate disk arrays under UNIX; neither UNIX nor the PCI computer need to be involved in the administration of these complex disk array configurations.

I.2 General Installation Notes

In the following description, we shall explain the installation of UnixWare in connection with the ICP Controller step by step. Apart from the UnixWare floppy disks, the CD-ROM and the UnixWare documentation, you also need the ICP floppy disk (can be created from the ICP System CDROM):

UnixWare BTLD-Disk

In the following discussion, when we speak of a *boot drive* we refer to the drive which is first integrated upon system power up. For the ICP Controller, this drive is the first Host Drive in the list of ICP Host Drives, i. e. the Host Drive with number 0 (see ICPCON menu *Configure Host-Drives*). During the installation you will have to decide whether you want the ICP Controller to make the boot drive available, or whether you want to operate the ICP Controller as an additional controller in the computer system. If the ICP Controller is the only hard disk controller in the computer system, it will automatically make the boot drive available.

If there are more hard disk controllers, the controller which makes the first drive (the drive containing the MS-DOS partition C:) available will be the boot controller. If the ICP Controller does not make the boot drive, you can skip the following paragraph.

I.3 ICP Controller as Boot Controller

There must be a Host Drive on the first ICP Controller found during a cold boot. In addition, the ICP BIOS must be enabled and the SCSI-ID of the corresponding ICP SCSI channel must be set to 7.

Now you can begin the installation. Boot the system with the first UnixWare boot disk. UnixWare scans the system for host adapters. When requested insert the *UnixWare BTLD-Disk*. The installation procedure which follows then has to be carried out as described in the UnixWare documentation.

Important note: As already mentioned in chapter B "Hardware Installation", the assignment of an IRQ to an INT is made by the PCI System BIOS. The UnixWare versions 2.xy and higher automatically recognize the IRQ of a PCI expansion card.

1.4 ICP Controller as an additional Controller

We distinguish two cases.

a.) No ICP Controller has been configured for UnixWare yet.

In this case, the ICP driver must be installed from the *UnixWare BTL-Disk* by means of the UnixWare desktop and the options "System Setup", "Application Setup". Alternatively, this procedure can be carried out from the UnixWare shell: "*pkgadd -d /dev/dsk/f0t*" (ICP driver disk in drive 0).

b.) An ICP Controller has already been configured for UnixWare.

In this case, you only have to add an additional entry for the new ICP Controller. This is carried out by

```
/etc/scsi/pdiadd -d DRQ -v IRQ -m MEM gdt
```

for DRQ use 0 (not necessary for PCI boards), for IRQ write the IRQ number the ICP Controller uses. MEM corresponds with the DPMEM address of the ICP Controller (which is displayed in the BIOS message of the ICP Controller after power up). In both cases, you have to carry out a cold boot in order to use the new ICP Controller under UnixWare.

Example: */etc/scsi/pdiadd -d 0 -v 12 -m c8000 gdt*.

After that, a reboot of the UnixWare system is necessary. No kernel link is required because the driver will be dynamically loaded.

1.5 Coordinates of SCSI devices

a.) Host adapter Number (HA)

The host adapter number assigned to the ICP Controller is derived from the PCI slot number of the ICP Controller. Therefore, if there is only one ICP Controller installed in the PCI bus computer system, the host adapter number=0. If there are two ICP Controllers installed, the ICP Controller with the lower PCI Slot number is assigned host adapter number 0 and the ICP Controller with the higher PCI slot number is assigned host adapter 1. (Note: After a cold boot, the ICP BIOS displays a couple of messages, each beginning with the controller's PCI slot number, e.g. "[PCI 0/3] 4 MB RAM detected". The number after the '/' is the slot number of the controller. This helps you to determine which is the order of the ICP Controllers and which host adapter number is assigned to them by UnixWare. See also chapter B, Hardware Installation).

b.) UnixWare Bus number, Target-ID and LUN

Target-IDs and LUNs for "Not Direct Access Devices" (devices like streamers, tapes and CD-ROMs and therefore not configurable via ICPCON), are directly assigned to the SCSI-ID and the channel of the ICP Controller. Host Drives are assigned in increasing order to the free coordinates (bus number and target ID; LUN is always 0).

Configuration Example:

In the PCI computer are two ICP Controllers (HA 0 = 1st ICP, HA 1 = 2nd ICP), each with two SCSI channels.

1 hard disk	as Host Drive no. 0 on HA0
1 hard disk	as Host Drive no. 0 on HA1
1 hard disk	as Host Drive no. 1 on HA1
1 Streamer	SCSI-ID 2, LUN 0 on SCSI channel A of HA0
1 CD-ROM	SCSI-ID 3, LUN 0 on SCSI channel B of HA0
1 DAT	SCSI-ID 2, LUN 0 on SCSI channel A of HA1

Result:

HA	Bus	Target-ID	LUN	Device
0	0	0	0	1 st hard disk, Host Drive no. 0 (boot drive)
0	0	2	0	Streamer
0	1	3	0	CD-ROM
1	0	0	0	hard disk, Host Drive no. 0
1	0	1	0	hard disk, Host Drive no. 1
1	0	2	0	DAT
1	0	3	0	hard disk, Host Drive no.2

1.6 Further Information

- During the installation of the ICP driver, additional tools are copied into the /etc directory. Before you can use them you have to create a special device file named /dev/rgdth by means of "link"; this device file has to be placed on a device of an ICP Host Drive. With 'gdtsync' from the /etc directory, you can determine the coordinates of an ICP Host Drive. Usually the first Host Drive has the coordinates c0b0t0d0. A special device file (character device) is '/dev/rdisk/c0b0t0d0s0'. In this case, /dev/rgdth can be generated with: `ln /dev/rdisk/c0b0t0d0s0 /dev/rgdth`. (c0 = HA, b0 = Bus number, t0 = Target-ID 0, d0 = LUN 0, s0 = UnixWare partition).
- All new SCSI devices will be automatically recognized and a corresponding special-device-file will be generated
- Host Drives must be partitioned and a file system/file system(s) must be created. You can do this with `diskadd cCbBtDd`.
- When using *Direct Access Devices* with **exchangeable media** (e.g., removable hard disks) that are not reserved for the raw service, a media has to be inserted either when the system is booted, or with ICPCON (mount/unmount), otherwise the device is not available under UnixWare.
- The ICP UnixWare driver supports *Direct Access Devices* (e.g., hard disks, removable hard-disks) as SCSI-raw devices. This is especially important if you use removable hard disks which you want to exchange with other controllers. How to reserve a device for the SCSI-raw service is described in the file `space.c` on the ICP BTLT disk (example and documentation).
- Multi-processor support: The ICP device drivers for UnixWare 2.xy and 7 support multi-processor systems.

Chapter J

ICP RAID Console
ICPCON

J. The Program ICPCON

ICP RAID Console (ICPCON) is an extremely helpful and flexible setup and diagnosis tool for the configuration, monitoring, maintenance and tuning of mass storage subsystems which are based on one or more ICP Controllers. Different to the **ICP RAID Navigator** (a GUI-style application for Windows 9x/NT/2000), ICPCON's user interface is character-oriented and available for all operating systems. (Information on the ICP RAID Navigator can be found in a separate chapter of this User's Manual.). In addition to that ICPCON is also part of the ICP Controller's Flash-RAM and can be loaded at system boot level by pressing <CTRL><G>.

Some of the key features of ICPCON:

- ICPCON includes both, diagnosis and configuration functions
- ICPCON is available as both, an executable program under various operating systems, and rom-resident program loadable with <CTRL>-<G> at system boot level (i.e., without any operating system)
- Host Drives can be setup and configured under normal operation
- Online Capacity Expansion of existing Disk Arrays
- Enhanced repair functions for Disk Arrays with failed drives
- Monitoring functions indicate the performance of the various components, Cache statistics
- Available for MSDOS, NetWare 3.x/4.x/5.x, Windows 9x, Windows NT, Windows 2000, Linux, SCO Unix
- Loadable locally (on the server) or remotely from an authorized workstation (support of various protocols); NetBIOS, IPX/SPX, TCP/IP.

J.1 Loading ICPCON

As mentioned before, the ICPCON program is available for various operating systems. It can be used either locally or remotely. This means that all ICP Controllers in a network can be monitored and serviced from one (or several) workstation(s).

J.1.1 Loading the ICPCON Program Under NetWare

The ICPCON program for NetWare is part of the ICP System CDROM. ICPCON can be used either under NetWare 3.x, NetWare 4.x, or NetWare 5.x. There are two different methods of loading ICPCON:

- loading ICPCON on the fileserver
- loading ICPCON on an authorized workstation (remote)

Loading ICPCON on the fileserver. Beforehand, the ICP NetWare driver and the auto-loading module CTRLTRAN must have been loaded on the fileserver.

LOAD ICPCON ENTER

on the fileserver.

Loading ICPCON on a workstation. In this case, too, the ICP NetWare driver and the auto-loading module CTRLTRAN must have been previously loaded on the fileserver console. In addition, the module CTRLIPX.NLM has to be loaded. This module searches for a file named CTRLIPX.CFG. This file must be located in the same directory as CTRLIPX.NLM.

The system administrator has to set up a user group named ICP_OPERATOR. All users belonging to this group are given access (through ICPCON) to the ICP Controller(s) in this specific fileserver (Access level 0). Now, the ICPCON program can be loaded from one (or more) workstation(s):

```
ICPCON ENTER
```

J.1.2 Loading the ICPCON Program Under Solaris 7

The ICPCON program for Solaris 7 is part of the ICP System CDROM. To load the program under Solaris 7, enter:

```
ICPCON ENTER
```

J.1.3 Loading the ICPCON Program Under Windows NT / 2000

The ICPCON program for Windows NT / 2000 is part of the ICP System CDROM. To load the program under Windows NT / 2000, enter:

```
ICPCON ENTER
```

For using ICPCON to monitor the server(s) remote, the MON4SOCK.DLL has to be loaded in addition (must be located in the same directory as ICPCON). It supports SPX/IPX and TCP/IP network protocols (for NetBIOS you can load instead MON4NETB.DLL).

J.1.4 Loading the ICPCON Program Under Windows 95/98

The ICPCON program for Windows 95/98 is part of the ICP System CDROM. To load the program under Windows 95/98, enter:

```
ICPCON ENTER
```

For using ICPCON to monitor the server(s) remote, the MON4SOCK.DLL has to be loaded in addition (must be located in the same directory as ICPCON). It supports SPX/IPX and

```
ICPCON ENTER
```

J.1.5 Loading ICPCON Under SCO UNIX

In order to be able to use the ICPCON program under SCO UNIX (2.x, 4.x and 5.x), it becomes necessary to substitute the standard terminal entry by a new one:

```
cd /usr/lib/terminfo ENTER
tic gdt386.src ENTER
```

Before each loading of ICPCON, this terminal has to be activated by:

```
TERM = gdt386 ENTER
export TERM ENTER
```

These two lines can also be inserted in the *.profile* file and will then be automatically processed during each login. The ICPCON program itself is copied during the SCO UNIX installation into the */etc* directory. ICPCON is loaded by entering:

```
icpcon ENTER
```

J.1.6 Loading ICPCON Under LINUX

The ICP System CDROM includes two archives:

```
icpcon.tgz          ICPCON and object files (intel)
icpcona.tgz        ICPCON and object files (alpha)
```

These archives include all object files to create ICPCON, as well as an executable ICPCON compiled on a current Linux version. If you encounter problems with this executable ICPCON, you can easily compile a new ICPCON on your own Linux system:

```
unpack the tgz-file:      'tar xvfz icpcon.tgz'
compile ICPCON:          'make'
start ICPCON:            './icpcon'
```

In order to be able to compile ICPCON you need the C-compiler and the Kernel sources on your system. The link */usr/src/linux* has to point to the Kernel sources which correspond with the currently booted Kernel of your system. This is important for "signature.c" to use the right magic for the communication with the driver. Otherwise it may happen that you get "Wrong signature" when trying to start ICPCON. ICPCON is loaded by entering:

```
icpcon ENTER
```

J.2 The ICPCON Program

As mentioned before, the ICPCON program appears identical for all operating systems. Thus, we can demonstrate the use and functioning of this program regardless of the operating system used. In previous chapters we have already described the hierarchical structure of the ICP firmware. We have defined 4 different levels of hierarchy: Level 1 where the physical devices named **Physical Devices** are found, level 2 containing the **Logical Drives** (made up of one or several *Physical Drives*), level 3 where we have the **Array Drives**, and finally, level 4 where the **Host Drives** are. Only the latter ones are known to the operating system. The drive of a given level of hierarchy is always set up by using the drives of the next lower level as components. Accordingly, ICPCON has various menu options, each referring to one level of hierarchy

Host Drives	_____	Level 4
Arrays Drives	_____	Level 3
Logical Drives	_____	Level 2
Physical Devices	_____	Level 1

The following summary gives you an overview of all Host Drive types you can create with the ICP Firmware. **The ICP Controller can *simultaneously* control several Host Drives of most various types.** For instance, MS-DOS drive C could be a Host Drive of the type disk (consisting of a single hard disk), MS-DOS drive D is a type RAID 5 Array Drive, MS-DOS drive E is a Host Drive of the type chain, and MS-DOS drive F is a CD-ROM which communicates with MS-DOS through corelSCSI and the GDT ASPI manager.

Type of Host Drive	Description of Host Drive	Minimum number of hard disks
Disk	1:1 assignment: Host Drive to hard disk (sometimes also called JBOD)	1
Chain	Concatenation of several hard disks	2
RAID 1	Mirroring	2
RAID 0	Data Striping	2
RAID 4	Data Striping with parity drive	3
RAID 5	Data Striping with striped parity	3
RAID 10	Combined RAID 0 and 1	4

After loading ICPCON, the following screen appears (by pressing F10 you may toggle between black and white display or colored display).

J.2.1 Select Interface

„Interface“ represents the method of how ICPCON connects with the ICP Controller. In this example „Win. 9x/NT/2k“ means that this ICPCON is the Windows version and is loaded on a Windows system.

If you press ENTER, ICPCON scans this local system for ICP Controllers. Instead of „Win. 9x/NT/2k“ you could also find here „Linux“, „NetWare“, etc.

Selecting „Sockets“ allows for the remote connection of this workstation with servers using ICP Controllers. You can either choose TCP/IP or IPX/SPX network protocols. In order to access the servers with ICP Controllers, the corresponding remote service must be loaded on the server. In addition the supervisor has to setup users and assign access rights (Name, password, see also chapter K.9)

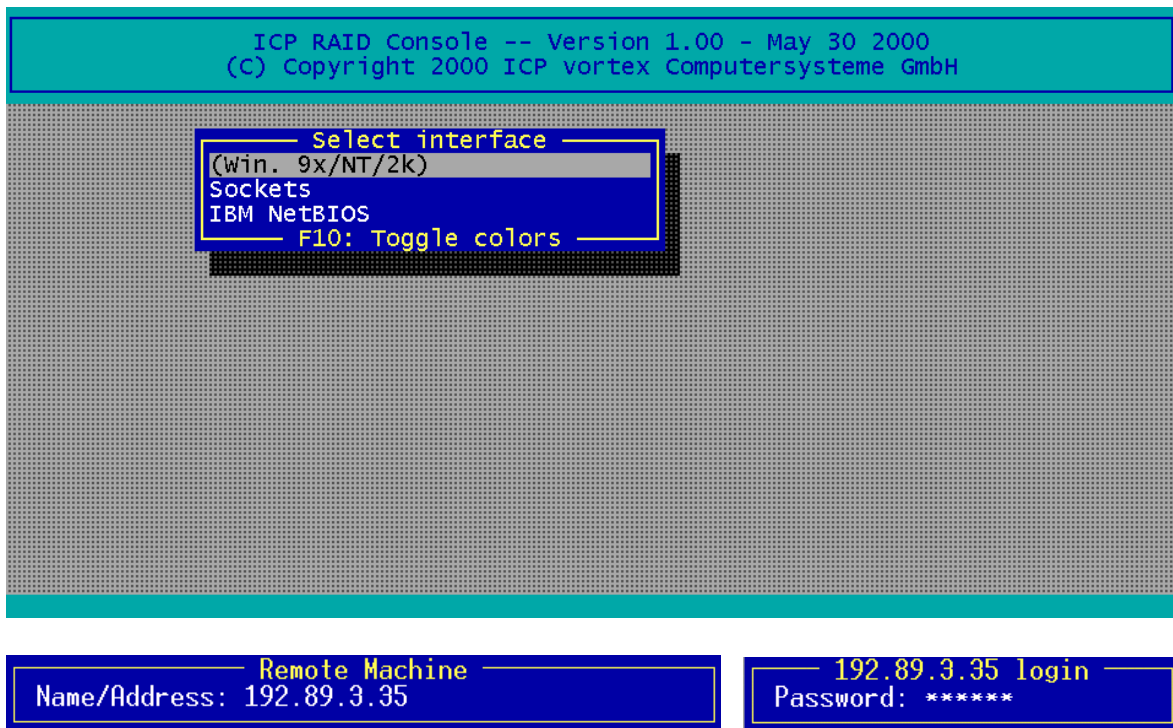

After selecting „Sockets“ and „TCP/IP“ you may enter the IP address of the server (if you would have chosen „SPX/IPX“ ICPCON would scan the network for suitable servers, which have SPX/IPX protocol). After that you may enter your user name and password.

J.2.2 Select Controller

After this login procedure ICPCON delivers a list of ICP RAID Controllers which are installed in this server (in this example one GDT7563RN). This list contains information on the controller name, the PCI Bus system (0=primary, 1=secondary, etc.) and separated with a slash the PCI slot number, the controller's features (C=Chaining, 0=RAID 0, 1=RAID 1, 4=RAID 4, 5=RAID 5, 10=RAID 10) and the firmware level. After selecting the controller with ENTER, all further settings and changes to these settings within ICPCON refer to this ICP Controller and the connected devices.

Select Controller				
No.	Name	Position	Features	Firmware
0	GDT7563RN	[PCI 0/1]	C 0 1 4 5 10	2.27.00-RFFF

F10: Toggle Colors

5=RAID 5, 10=RAID 10) and the firmware level. After selecting the controller with ENTER, all further settings and changes to these settings within ICPCON refer to this ICP Controller and the connected devices.

J.2.3 The two Menu Areas „Monitor“ and „Express/Advanced Setup“

ICPCON offers two fundamentally different operating modes:

- *Express Setup / Advanced Setup* with configuration functions
- *Monitor* with monitoring functions

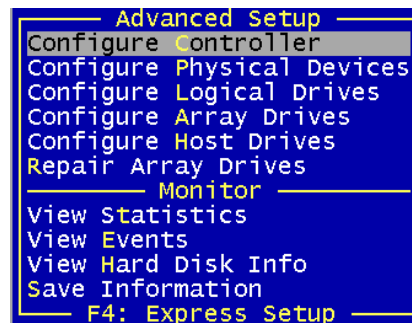
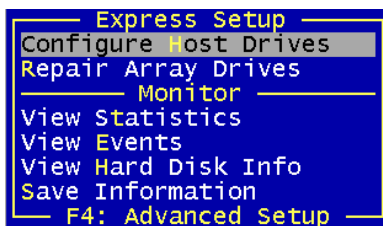

The various menu options can be selected either with the cursor up/down keys, or by pressing the high-lighted character. F4 allows the switching between the Advanced Setup and Express Setup modes.

Monitor	Express Setup / Advanced Setup
<ul style="list-style-type: none"> ▪ With „View Statistics“ you may supervise the performance of the different components of the RAID subsystem. ▪ „View Events“ is an enhanced event recorder for RAID and controller specific events. ▪ With „View Hard Disk Info“ you can view detailed information on the connected devices (important are the retries, reassigns, grown defects and last status information) 	<ul style="list-style-type: none"> ▪ „Configure Controller“ allows you to setup the ICP Controller. Here, you can change the Cache settings, the termination, the memory test, etc. ▪ With „Configure Physical Devices“ you can initialize the devices at physical level, e.g., change the SCSI protocol, transfer rates, etc. ▪ „Configure Logical Drive“ allows you to configure or create Logical Drives.

- „Save Information“ creates a complete protocol file of the current RAID sub-system including all settings of the ICP Controller and the drives. This file can be used for documentary reasons or for remote diagnosis.
- „Configure Array Drives“ allows you to configure or create Array Drives.
- With „Configure Host Drives“ you can either configure already existing Host Drives, or create new ones. I.e., you can create under normal operation new Host Drives without shutting down the computer.
- The „Repair Array Drives“ menu offers very powerful menu-guided functions to repair Array Drives which have failed drives.

J.3 The Menu Monitor

J.3.1 Menu Monitor: View Statistics

In each of these menus, ICPCON displays the performance of the drives of the corresponding level of hierarchy. The throughput of the drives is displayed in KB/s (KiloBytes per second) and IO/s (I/Os per second, number of IO's on the controller). The performance figures reflect the load being on the controller and not necessarily the maximum performance the controller can deliver.

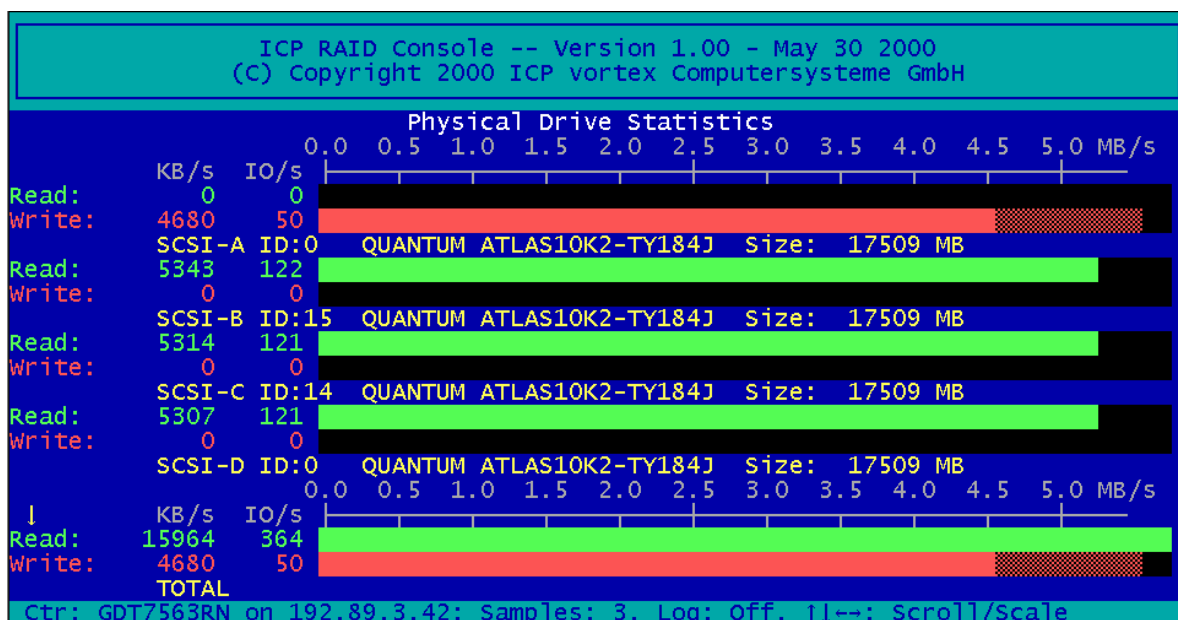
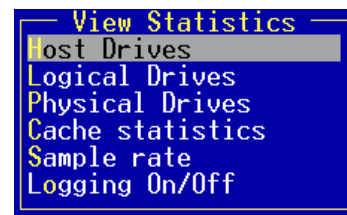

After selecting one of the Drives Statistics ICPCON displays a list of all Drives of this level (for this example the Physical Drives, i.e., level 1). In addition to the performance report on the Drives, you are given additional information on each device. The ICP I/O channel the hard disk is connected to, which ID the hard disk has, the name of the hard disk, the gross

capacity (1MB = 1024KB). The figures shown at TOTAL represent the overall performance of the Host Drives as a whole. With the ← and → keys you may change the scale of the graphical KB/s indication. With the ↑ and ↓ keys you can scroll the screen to see further Drives (if available).

After selecting the menu option „Cache Statistics“ you can view the utilization of the ICP Controller's Caches, separated in the Read Cache and the Write Cache. This menu also displays the size of the Cache in KB and the settings of both Caches (On, or Off). The figures for „Cache Hits“ show the how often requests can be serviced out of the cache, i.e., without triggering an immediate Disk IO.

By setting the „Sample Rate“, you can choose the interval at which the ICP Controller delivers new measurements. According to the operating system used, the sampling rate can be set to a maximum of 60 seconds. The default setting is 1 second.

Logfile: `hoststat.log`

With „Logging On/Off“, you may create a log file which records all the statistic values over a longer period. If you choose On, ICPCON asks for the path/name of the log file.

J.3.2 Menu Monitor: View Events

With „View Events“ ICPCON displays all ICP Controller Events. They can also be recorded and saved into a log file. This function gives the administrator a good help to analyze and supervise ICP Controllers with Array Drives.

Controller Events						
Ctr	Time	Cnt	Evt	Text		
0	Thu Jan 01 01:00:00 1970	1	20	Array Drive 3: parity build finishe...		
0	Thu Jan 01 01:00:00 1970	1	42	Array Drive 3: parity build started		
0	Thu Jan 01 01:00:00 1970	1	56	Host Drive 7 created		
0	Thu Jan 01 01:00:00 1970	1	52	Array Drive 3: expand finished succ...		
0	Thu Jan 01 01:00:00 1970	1	51	Array Drive 3: expand started		
0	Thu Jan 01 01:00:00 1970	1	20	Array Drive 3: parity build finishe...		
0	Thu Jan 01 01:00:00 1970	1	42	Array Drive 3: parity build started		
0	Thu Jan 01 01:00:00 1970	1	60	Array Drive 3: parity build aborted		
0	Thu Jan 01 01:00:00 1970	1	42	Array Drive 3: parity build started		
0	Thu Jan 01 01:00:00 1970	1	20	Array Drive 3: parity build finishe...		
0	Thu Jan 01 01:00:00 1970	1	42	Array Drive 3: parity build started		

↑↓: scroll, F8: clear, F2: save + clear

J.3.3 Menu Monitor: View Hard Disk Info

This menu shows for all Drives :

ICP RAID Console -- Version 1.00 - May 30 2000 (C) Copyright 2000 ICP vortex Computersysteme GmbH							
Hard Disk Information							
Chn	ID	Vendor	Product	Retr./Reass.	Grown	Def.	Last Status
SCSI-A	0	QUANTUM	ATLAS10K2-TY184J	0/0	0	0	0x00000000
SCSI-B	15	QUANTUM	ATLAS10K2-TY184J	0/0	0	0	0x00000000
SCSI-C	14	QUANTUM	ATLAS10K2-TY184J	0/0	0	0	0x00000000
SCSI-D	0	QUANTUM	ATLAS10K2-TY184J	0/0	0	0	0x00000000
SCSI-E	1	IBM	DPSS-309170M	0/0	0	0	0x00000000
SCSI-E	3	IBM	DPSS-309170M	0/0	0	0	0x00000000
SCSI-E	6	IBM	DDYS-T18350M	0/0	0	0	0x00000000
SCSI-F	6	QUANTUM	ATLAS10K2-TY184J	0/0	0	0	0x00000000

- the SCSI channel
- the SCSI-ID
- the vendor and type
- Retries/Reassigns, Grown Defects and the Last Status

(1) The *Retries* counter is incremented by one unit whenever the ICP Controller retries to access a hard disk. If this counter continues to increase (possibly on other hard disks, too) it is very likely that the cable is not *good* enough for the selected data transfer rate (cable too long, poor quality of cable and connectors), or that the SCSI bus is not properly terminated (too many terminators on the cable, or missing terminator). In very few cases is the hard disk concerned defective. The retry counter also increases when the SCSI parameters of a hard disk are changed (see further ahead). Obviously, retries due to this do not imply bad cabling.

(2) The reassign counter reflects the number of media defects which occur on the hard disk drive. Defective blocks of the hard disk are assigned substitute blocks (spare blocks) which are either on the same track, or on alternate ones if all spare blocks on the same track are already in use. The administration of the reassignments is carried out by the hard disk through according reassignment tables. Note: If a hard disk works with alternate tracks, it is generally no longer suitable for applications with high performance expectations. Whenever a defective block is being accessed, the read/write actuator has to move to an alternate position and this requires extra time.

If you observe that the number of reassigns is constantly increasing, you may suspect that something is wrong with this drive.

(3) The Grown Defects counter shows the number of media defects which have occurred since the first time the device was operated with an ICP Controller. A specific hard disk is in a good condition when it has 0 grown defects. When this counter increases, there is definitely something wrong with the device.

(4) The Last Status information should always be 0x00000000. After a device failure or other significant events, a different value may be displayed here. This value is volatile and is reset to 0x00000000 after each power up and/or reset.

If you press ENTER on a Drive, ICPCON display further information on the SCSI parameter settings.

```

Hard disk Information
Name .....: QUANTUM ATLAS10K2-TY184J
Capacity .....: 17509 MB

Sync. Transfer .....: Enabled
Sync. Transfer Rate : 160.0 MB/s
Sync. Transfer Mode.: DT
Data Path Width ....: Wide
Domain Validation ..: On
Disconnect .....: Enabled
Disk Read Cache ....: On
Disk Write Cache ...: On
Tagged queues .....: On

Grown defects .....: 0
Last status .....: 0x00000000

```

J.3.4 Menu Monitor: Save Information

The *Save Information* option gives you the possibility to save the configuration information regarding the selected ICP Controller and its devices in an ASCII-file. This may help if you require support and is also good for your system documentation.

At the end of this protocol is a chronological listing of boot messages and other events stored in the Flash-RAM of the ICP Controller. If the buffer is full, the oldest events are deleted first.

```

View Information
ICP RAID Console -- Version 1.00 - May 30 2000
=====
Date/Time:      Tue Jun 13 11:27:41 2000
Operating system: Windows 9x/NT/2000, Version: 5.00, Rev. 2195
Processor:      x86 Family 6 Model 7 Stepping 2
Physical memory: 130596 KB

Controller Information
=====
Type:           GDT7563RN      Slot/Address:    0/1
Firmware version: 2.27.00-RFFF      Serial no.:      FFEFFFFFFF
Features:       C 0 1 4 5 10  Channel count:    6
Cache:          On           Delayed write:   On
Hardware level: 0           Cache RAM:       64 MB, 2 bank(s)

```

In the menu „Configure Controller“ the logging buffer can be cleared with „Clear Log Buffer“. The logging list is a good source to analyze complex events and problems.

```

View Information
Screen service messages / Async. events
=====
Tue Jun 13 14:16:52 2000: Array Drive 3: parity build finished successfully
Tue Jun 13 14:13:34 2000: Array Drive 3: parity build started
Fri Jun 09 13:36:25 2000: Host Drive 7 created
Fri Jun 09 13:36:25 2000: Array Drive 3: expand finished successfully
Fri Jun 09 13:24:59 2000: Array Drive 3: expand started
Fri Jun 09 13:24:36 2000: Array Drive 3: parity build finished successfully
Fri Jun 09 13:21:42 2000: Array Drive 3: parity build started
Fri Jun 09 13:21:18 2000: Array Drive 3: parity build aborted
Fri Jun 09 13:19:34 2000: Array Drive 3: parity build started
Fri Jun 09 13:18:25 2000: Array Drive 3: parity build finished successfully
Fri Jun 09 13:14:45 2000: Array Drive 3: parity build started
Fri Jun 09 11:39:24 2000: RAID-5 Host Drive 3 installed (ready)
Fri Jun 09 11:39:24 2000: RAID-5 Host Drive 0 installed (ready)
Fri Jun 09 11:39:23 2000: SCSI-E ID:6 LUN:0 -- IBM      DDYS-T18350M
Fri Jun 09 11:39:23 2000: SCSI-E ID:3 LUN:0 -- IBM      DPSS-309170M

```

J.4 The Menu Express/Advanced Setup

J.4.1 Menu Express Setup: Configure Host Drives

This function allows a very easy installation of new Host Drives and does not require any special knowledge. Apart from minor differences, this menu option is identical with the menu option „Configure Host Drives“ in the Advanced Setup (in Express Setup, the user may not select a stripe size (defaults to 128KB) or use the Split/Merge functions.)

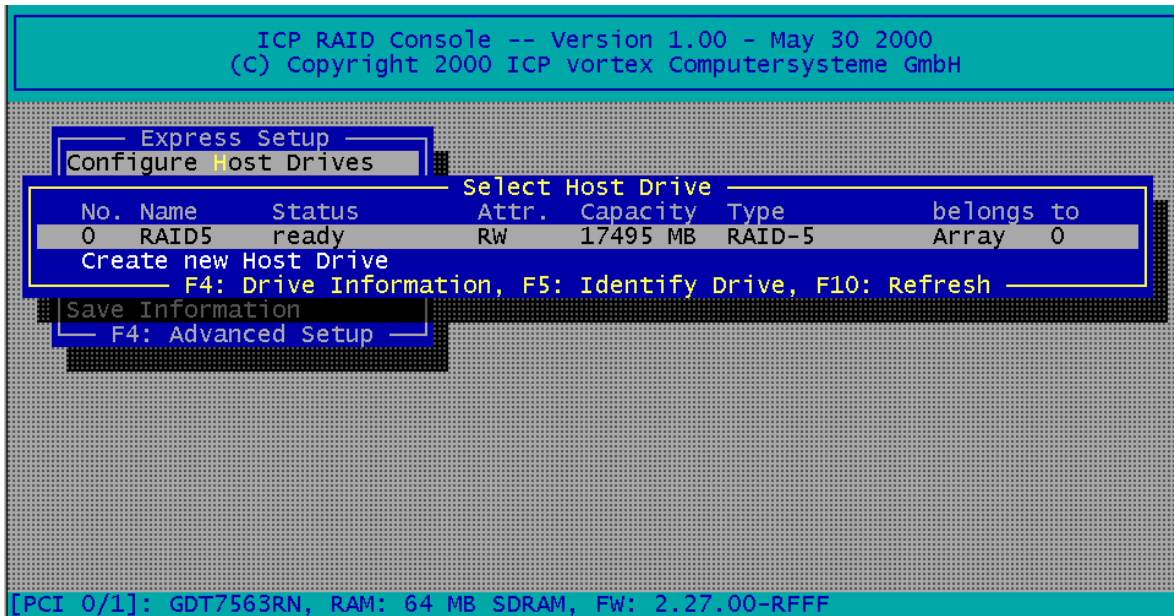

After selecting Configure Host Drives, ICPCON displays a list of already existing Host Drives. With a new system this list will show no entries. In this example there is already one Host Drive available. It's name is "RAID 5" and it is an RAID 5 Array Drive (with approx. 17GB capacity). The status is "ready". I.e., this Host drive is fully available and redundant. The following states for RAID Host Drives are possible:

"Idle" State

This state is characterized by the fact that the redundant information of the disk array has never been entirely created. The disk array is in this state after its first configuration and until you quit ICPCON. If an error should occur while the array is in the *build* state, the array returns to the *idle* state (exception: if during *build* mode the dedicated drive of RAID 4 fails, the mode changes to *fail*).

"Build" State

After the disk array has been configured for the first time, it assumes the *build* state as soon as you quit ICPCON. While the array is in the *build* state, redundancy information is calculated and stored to the hard disks of the array.

"Ready" State

The disk array is fully operational when in the *ready* state. All redundant information is present, that is, a hard disk can fail without impairing the functionality of the disk array. This is the normal state of a disk array. The state *ready/expand* indicates, that the RAID level and/or capacity are currently migrated/expanded.

"Fail" State

The disk array changes to the *fail* state whenever a Logical Drive fails. Redundancy information is still present, thus allowing the remaining hard disks to continue working. This state should be eliminated as soon as possible by replacing the defective hard disk. If a so-called Hot Fix drive has previously been assigned to a disk array with ICPCON, the controller will automatically replace the defective drive and start the reconstruction of the data and the redundant information. Therefore, under these circumstances the *fail* state is only temporary and will be eliminated by the controller itself.

"Rebuild" State

The disk array will assume this state after the automatic activation of a Hot Fix drive or after a manual replacement carried out with ICPCON. The data and the redundant information are reconstructed and stored to the new drive.

"Expand" State

If the capacity or RAID level of an existing disk array is changed, the disk array changes its state into *expand*. As soon as the expansion or migration is completed, the state changes back to *ready*.

"Error" State

If a second hard disk should fail while the disk array is in the *fail* or *rebuild* state, it is not possible to continue the working session without restrictions. The disk array is still available for I/Os, but data loss and error messages on the host level are possible.

The following state diagram of the disk array summarizes the states described above and the transitions from one state to another.

Some of these states may become the addendum **patch** (e.g. *build/patch*, *ready/patch*).

This word indicates that the original Array Drive went through a significant procedure. I.e., the parity information was recalculated anew.

Or, the Array Drive has been patched from the error state into the fail state. This may become extremely helpful in a situation where two Logical Drives of an Array Drive, fail at the same time, but only one of the two Logical Drives is really defective and the other was blocked out, since it was connected with the same SCSI channel as the defective one. The Array Drive's state is error and normally all data would be lost. The ICP Controllers include some functions, which allow the patch of this Array Drive from the error state into the fail state. Before the actual patch, the defective drive has to be physically removed from the Array Drive. Such a patch-procedure is a real sheet-anchor and should only be used, after a detailed consultation with a trained support person (a printout of the *Save Information* file, is extremely helpful).

Pressing F4 delivers level by level detailed information on a Host Drive and its components. This may assist to get an easy overview of a specific Host Drive. After pressing F5 the ICP Controller switches the LEDs (if available) of the hard disks belonging to that Host Drive on and off.

After selecting „Configure new Host Drive“, the ICP Controller scans all channels for free hard disks (i.e., hard disks which are not yet part of a Host Drive) and displays these units in a list. Use the Space bar to select/deselect hard disks and the cursor up down keys to move the selection bar from one hard disk to another. Marked hard disks show an "*" in the first column. In the choose Type windows all possible Host Drive types are displayed (the possible types depend on the number of selected hard disks and the firmware level of the ICP Controller).

Finish the selection by pressing ENTER.

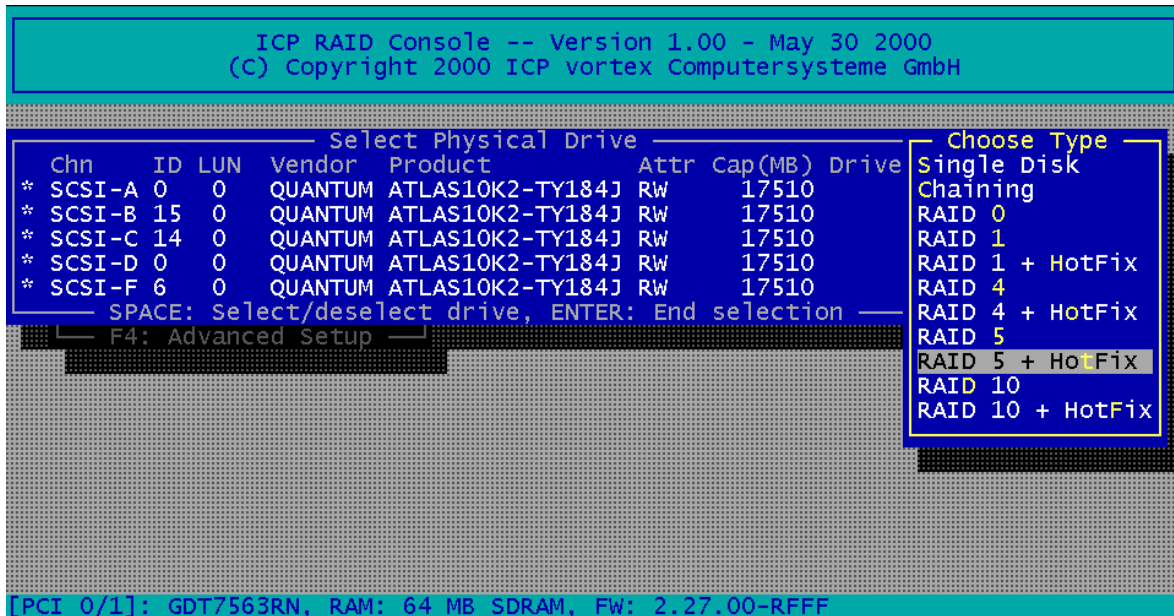

ICPCON displays a security message pointing out that all existing data on the selected hard disks will be destroyed after confirming with Yes.

Do you want to create a host Drive from the selected disk(s) ?
(CAUTION: All data will be destroyed !) (Y/N)

After pressing "Y" the user may limit the capacity per hard disk which will be used for the Host Drive. This can be very helpful for the procurement of future spare hard disks. After

Used Capacity per Drive (1..17509 MB): 17000_

that ICPCON automatically creates and configures the new Host Drive and adds it to the list. All SCSI parameters are adjusted to optimum values.

No.	Name	Status	Attr.	Capacity	Type	belongs to
0	RAID5	ready	RW	17495 MB	RAID-5	Array 0
3	RAID5	build	RW	52528 MB	RAID-5	Array 3

Create new Host Drive
F4: Drive Information, F5: Identify Drive, F10: Refresh

After leaving ICPCON or after pressing F10 (for refresh) the ICP Controller starts the build process on this Host Drive. In our example it calculates the parity information and writes it to the hard disks. The status during this process is build. When the build is successfully finished the status changes into ready.

If you press ENTER on a Host Drive the following options become available:

"Change Drive Name" allows you to change the name of a Host Drive. The name serves to identify a Host Drive with ICPCON. E.g., you could name the boot Host Drive "Boot" and the data Host Drive "Data".

"Swap Host Drives". When the PCI computer is switched on, the Host Drives are initialized in the order of the Host

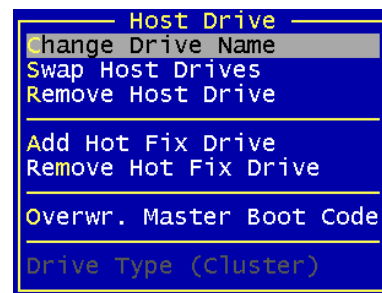

Drive list, which means that the operating system is booted from the Host Drive having the lowest number. For reasons of flexibility, a Host Drive's position in the list can be changed. However, the position of the Host Drive from which the operating system is booted and the position of the Host Drive from which ICPCON (disk version) was started (both can be the same), cannot be changed. If you wish to change the position of these drives, you have to boot the operating system and ICPCON from a floppy disk or use the ICPCON from the Flash-RAM of the ICP Controller. To change the position of a Host Drive in the Host Drive list, highlight the Host Drive and confirm with ENTER. Then, type on the new position and press ENTER.

“Remove Host Drives”. Removing a Host Drive is a serious action. **All data will be lost after removal.** If you want to remove a Host Drive belonging to an Array Drive for which several Host Drives exist (after capacity expansion, or after splitting), all other Host Drives will also be removed.

“Split Host Drive”. For some purposes it might of interest to split an existing Host Drive into two or several Host Drives. Each Host Drives looks to the operating system just like a single hard disk. Since the new Host Drives have smaller capacities ICPCON has to write new header information on the two Host Drives. **All data will be lost.**

“Merge Host Drives”. This function reverses the *Split Host Drive* option. Only such Host Drives can be merged which belong to the same Array Drive or Logical Drive. Since the new Host Drives has a larger capacity ICPCON has to write a new header information on the new Host Drives. **All data will be lost.**

“Partition Host Drive”. This option is not available, when loading ICPCON from the Flash-RAM of the ICP Controller. Before you can partition a new Host Drive it may become necessary to reboot the system, first. The partitioning menu has similar functions as the MS-DOS program FDISK. You can create and delete a partition and also change the active partition. MS-DOS can only be booted from an active partition. Just like FDISK, ICPCON can handle primary partitions, extended partitions, and logical drives within the extended partitions.

“Add Hot Fix Drive” allows you to add a Hot Fix drive to an existing RAID 1, RAID 4, RAID 5, or RAID 10 Array Drive. There are two different types of Hot Fix drives: *Private* and *Pool* Hot Fix drives. A *Pool* Hot Fix Drive is a spare drive within the so-called Hot Fix Pool. A drive in a Hot Fix Pool is available for several Array Drives as a Hot Fix drive. Thus, several Array Drives can share one Hot Fix drive. Of course, once this drive has been used by one of the Array Drives, it is no longer available for the others.

A *Private* Hot Fix drive is dedicated to one RAID 1, RAID 4, RAID 5 or RAID 10 Array Drive.

“Remove Hot Fix Drive” allows you remove a previously assigned Hot Fix drive.

“Overwrite Master Boot Code”. This option creates a valid and consistent master boot record on the selected Host Drive and should be carried out on any new Host Drive on which Windows NT is installed. **Never use this function when the Host Drive contains valid data, all data will be lost.**

The option “Drive Type (Cluster)” is available only with ICP Controllers which are equipped with Cluster RAIDYNE® (GDTx6xxx) and allows to assign one Host Drive to several ICP Controllers (Type Cluster).

J.4.2 Menu Express Setup: Repair Array Drives

This function allows the online repair of Array Drives which show failed drives. After selecting this menu option, ICPCON displays a summary of all installed Array Drives (in this example 2) and the number of Array Drives which are in critical states.

In this example there is one Array Drive in the FAIL state. I.e., the Array Drive is still operating but longer redundant.

After pressing any key, ICPCON displays a list of Array Drives which are candidates for this online automatic repair. Note: Array Drives which have the „ERROR“ state are very critical and have lost 2 or even more drives. These Array Drives cannot not be repaired with this function. In such critical cases the data integrity can longer be maintained. You may call our technical support center for further assistance.

```

Summary
2 Array Drives installed
1 Array Drives in FAIL state
0 Array Drives in ERROR state
0 Array Drives in BUILD state
0 Array Drives in REBUILD state
0 missing Private HotFix Drives

Press any key.

```

After selecting the Array Drive, ICPCON display the actual drive which has failed. In this example it is the hard disk which forms Logical Drive 5.

```

Select Drive to repair
No. Name Type State
2 RAID5 RAID-5 fail

```

After confirmation, the failed drive has to be taken out and the new one has to be configured on the same ID as plugged in again.

```

Monitor
Repair Array Drives
Vi Select Drive to repair
Vi No. Name Type State
Vi 2 RAID5
Sa F4: Config

Physical Disk SEAGATE ST39175LC
at channel SCSI-B, ID 10,
which belongs to Logical Drive 5
failed. Do you want to replace it? (Y/N)

```

```

The Disk SEAGATE ST39175LC at channel SCSI-B, ID 10 will be replaced.
Please plug in a disk at the same channel with the same ID.
YOU MUST NOT DO ANY UNPLUGGING OR PLUGGING ON OTHER CHANNELS

Press any key after hot plug.

```

ICPCON detects the new drive and expects a clearance to build this drive as a replacement into the Array Drive.

```

You plugged in the disk SEAGATE ST39175LC , ID 10 at channel SCSI-B.
Do you want to add this disk to the Array? (Y/N)

```

After that the state of the Array Drive changes into „REBUILD“, i.e. the missing data is reconstructed out of the remaining data and the redundancy information.

```

Summary
2 Array Drives installed
0 Array Drives in FAIL state
0 Array Drives in ERROR state
0 Array Drives in BUILD state
1 Array Drives in REBUILD state
0 missing Private HotFix Drives

Press any key.

```

The „ERROR“ state of an Array Drive is very critical. There are several procedures in the ICP Controller's firmware to handle such cases and bring back the Array Drive in operation without losing data. The most suitable procedure for the specific case, should be elaborated with your system administrator or our technical support. (Note: ICP vortex offers 2-day RAID Workshops in our training center, which also focus on the resolution of such problems.

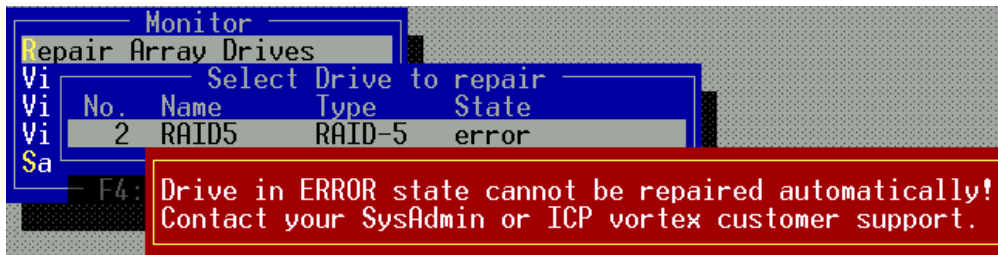

J.4.3 Menu Advanced Setup: Configure Controller

J.4.3.1 Menu Advanced Setup: Configure Controller, Controller Settings

Within the Controller Settings all relevant parameters and settings concerning the ICP Controller itself can be changed. All information concerning Physical, Logical, Array and Host Drives are stored twice (*primary and secondary configuration data*) on each hard disk. I.e., the ICP Controller itself carries no configuration data of a specific disk array. Out of this reason, the migration of Host Drives between ICP Controllers is very easy and secure, even if the SCSI IDs and channels are changed. Simply connect the hard disks to the new ICP Controller, and the Host Drives will automatically be available again. The various parameters and settings have the following meaning:

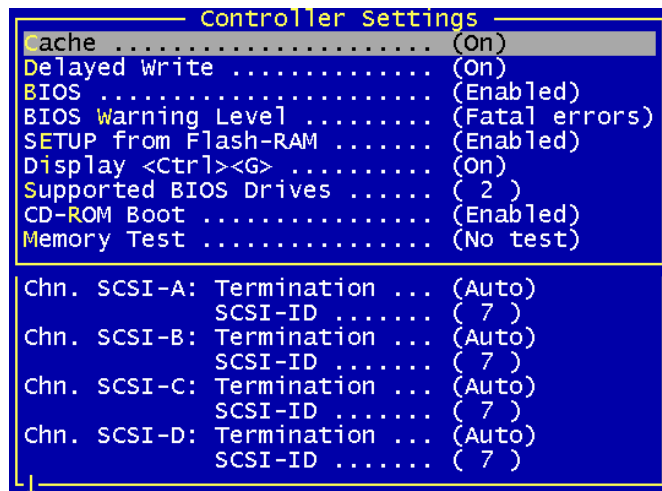

Parameter	Alternatives	Description
Cache	On	ICP Controller cache (write and read cache) On
	Off	ICP Controller cache (write and read cache) Off
Delayed Write	On	Write cache On
	Off	Write cache Off
BIOS	Enabled	BIOS enabled
	Disabled	BIOS disabled, but <CTRL><G> allowed
	Removed	BIOS and <CTRL><G> disabled
BIOS Warning Level	All Messages	All ICP BIOS warnings and errors are displayed
	Fatal Errors	Only fatal messages are displayed
SETUP from Flash-RAM	Disabled	<CTRL><G> not possible
	Enabled	<CTRL><G> allowed

Display <CTRL><G>	Off On	<CTRL><G> not displayed at system boot level <CTRL><G> displayed at system boot level
Supported BIOS Drives	2 7	The ICP BIOS supports 2 drives under MS-DOS The ICP BIOS supports 7 drives under MS-DOS
CD-ROM Boot	Enabled Disabled	Boot from CD-ROM enabled Boot from CD-ROM disabled
Memory Test	No test Standard Double scan Intensive	No test at all Standard test Double scan test Intensive test (takes longer)
Chn. SCSI-A Termination	Off On Auto	SCSI termination of the channel Off SCSI termination of the channel On SCSI termination according to occupied connectors
SCSI-ID	0,1,2,3,4,5,6,7	Possible SCSI IDs of the channel

J.4.3.2 Menu Advanced Setup: Configure Controller, Firmware Update

The firmware, the BIOS and the ICPCON program of the ICP Controller are stored in a Flash-RAM which is part of the ICP Controller hardware. In contrast to EPROMs, Flash-RAMs can be re-programmed many times and without the complicated UV-light erasing procedure. Firmware, BIOS and ICPCON are part of the **GDT_RPFW** file. The file has an extension (e.g. GDT_RPFW.009) which indicates the version stepping. The latest version of this file can be downloaded from our Website (www.icp-vortex.com). This menu option is not available when ICPCON is accessing the ICP Controller remotely.

J.4.3.3 Menu Advanced Setup: Configure Controller, Intelligent Fault Bus

Intelligent Fault Bus is an older subsystem standard, which is no longer used in modern subsystems or backplanes. ICP's Ultra/Wide Disk Array Controllers were the last ICP Controllers supporting this, sometimes also called "DEC™ Fault Bus". Today's modern subsystems are either using SAF-TE (SCSI Accessed Fault Tolerant Enclosures) or SES (SCSI Enclosure Services) as communication links to the controller. These intelligent subsystems are normally built on so-called backplanes, which host hard disks which are equipped with SCA connectors (Single Connector Attachments). The backplane has a dedicated electronics with microprocessor and firmware which allows an intelligent communication between the subsystem/backplane and the ICP Controller. Through this channel the subsystem can for example report its temperature and the power supply status to the ICP Controller. The major objective of SAF-TE or SES is to provide the Auto Hot Plug. In contrast to the Hot Plug, a defective drive is simply pulled out of the subsystem and the replacement unit is plugged in again. Both, the ICP Controller and the subsystem control this process so that problems on the SCSI/FC-AL bus are eliminated and the rebuild of the missing data is initiated fully automatically. No further user interaction is necessary.

A unique and special feature of ICP Controllers is the following:

J.4.3.4 Menu Advanced Setup: Conf. Controller, Non-Intelligent Enclosures

Since SAF-TE or SES subsystems are pretty cost intensive, ICP has integrated a special functionality which can control up to 16 non-intelligent enclosures with up to 15 hard disk, each, and provides the Auto-Hot-Plug. It is clearly up to the user's responsibility to use components (e.g., disk shuttles), which are really hot pluggable.

Select Enclosure			
No.	Vendor	Name	Status
0	MALIBU	PA46-350	Configured
1			Not Configured
2			Not Configured
3			Not Configured
4			Not Configured
5			Not Configured
6			Not Configured
7			Not Configured
8			Not Configured
9			Not Configured
10			Not Configured
11			Not Configured
12			Not Configured
13			Not Configured
14			Not Configured
15			Not Configured

ENTER: Select, F4: Edit Vendor/Name

In this example one subsystem is already defined. Naturally, the hard disks with their disk shuttles could be also directly mounted in the server enclosure. The term "Enclosure" in these cases is more a definition set, which includes all hard disks which should be auto hot pluggable.

The following example shows the slots of the enclosure which have been assigned with hard disks. To fill an empty slot, press ENTER and select the desired hard disk.

Enclosure Slots								
Slot	Chn	ID	LUN	Vendor	Product	Attr.	Cap(MB)	Drive
0	SCSI-A 0	0	0	i	QUANTUM ATLAS10K2-TY184J	RW	17509	Drive 4
1	SCSI-B 15	0	0	i	QUANTUM ATLAS10K2-TY184J	RW	17509	Drive 5
2	SCSI-C 14	0	0	i	QUANTUM ATLAS10K2-TY184J	RW	17509	Drive 6
3	SCSI-D 0	0	0	i	QUANTUM ATLAS10K2-TY184J	RW	17509	Drive 7
4	SCSI-E 1	0	0	i	IBM DPSS-309170M	RW	8747	Drive 0
5	SCSI-E 3	0	0	i	IBM DPSS-309170M	RW	8747	Drive 1
6	SCSI-E 6	0	0	i	IBM DDYS-T18350M	RW	17501	Drive 2
7	SCSI-F 6	0	0	i	QUANTUM ATLAS10K2-TY184J	RW	17509	Drive 3
8	No hard disk installed in this slot							
9	No hard disk installed in this slot							
10	No hard disk installed in this slot							
11	No hard disk installed in this slot							
12	No hard disk installed in this slot							
13	No hard disk installed in this slot							
14	No hard disk installed in this slot							
15	No hard disk installed in this slot							

ENTER: Add/Remove Disk

Enclosure Slots								
Slot	Chn	ID	LUN	Vendor	Product	Attr.	Cap(MB)	Drive
0	SCSI-A 0	0	0	i	QUANTUM ATLAS10K2-TY184J	RW	17509	Drive 4
1	SCSI-B 15	0	0	i	QUANTUM ATLAS10K2-TY184J	RW	17509	Drive 5
2	SCSI-C 14	0	0	i	QUANTUM ATLAS10K2-TY184J	RW	17509	Drive 6
3	SCSI-D 0	0	0	i	QUANTUM ATLAS10K2-TY184J	RW	17509	Drive 7
4	SCSI-E 1	0	0	i	IBM DPSS-309170M	RW	8747	Drive 0
5	SCSI-E 3	0	0	i	IBM DPSS-309170M	RW	8747	Drive 1
6	SCSI-E 6	0	0	i	IBM DDYS-T18350M	RW	17501	Drive 2
7	No hard disk installed in this slot							

Select Disk								
Chn	ID	LUN	Vendor	Product	Attr.	Cap(MB)	Drive	
SCSI-F 6	0	0	i	QUANTUM ATLAS10K2-TY184J	RW	17509	Drive 3	

ENTER: Select Disk

12	No hard disk installed in this slot							
13	No hard disk installed in this slot							
14	No hard disk installed in this slot							
15	No hard disk installed in this slot							

ENTER: Add/Remove Disk

It should be outlined again, that SAF-TE and SES are definitely the better choices for auto hot pluggable subsystems. Only with these systems a secure Auto Hot Plug is guaranteed.

With the non-intelligent subsystems we highly recommend you to use only best quality components (disk shuttles, cables, terminators, etc.).

J.4.3.5 Menu Advanced Setup: Configure Controller, Advanced Settings

Within Advanced Settings there are three settings which control the configuration and address behavior of the ICP Controller's BIOS and DPMEM. Normally, there is nothing to change here.

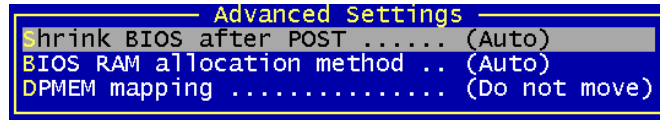

Parameter	Alternatives	Description
Shrink BIOS after Post	Off	The BIOS is not shrunk after the post phase
	On	The BIOS is always shrunk after the post phase
	Auto	The ICP Controller decides on the BIOS shrink
BIOS RAM allocation method	Auto	The BIOS address space is automatically allocated
	Older	The BIOS address space is allocated according to an older PCI specification
DMEM mapping	Move below 1MB	The DPMEM address space is allocated below 1MB
	Do not move	The DPMEM address space is always above 1MB

J.4.3.6 Menu Advanced Setup: Configure Controller, Cluster Settings

This menu is selectable only with ICP Controllers which are equipped with Cluster RAIDYNE® and allows the user to enable the IO channels of the ICP Controller for clustering. Special care must be taken, that the IO-Processors of a shared channel (SCSI or Fibre Channel) have different IDs, otherwise there will be conflicts.

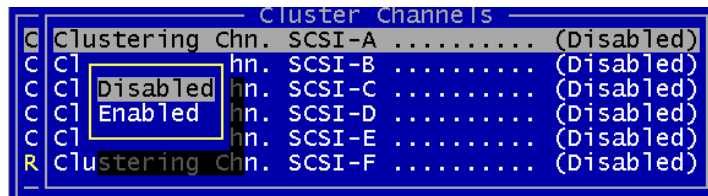

J.4.3.7 Menu Advanced Setup: Configure Controller, Clear Log Buffer

The ICP Controller records certain events in a logging buffer which is part of the Flash-RAM. If it is planned to use the ICP Controller in a completely new system, it is sensible to clear all events in this buffer. The Clear Log Buffer function detects possible entries and deletes them.

J.4.4 Menu Advanced Setup: Configure Physical Devices

After selection of this menu option ICPCON displays a list of the IO channels (SCSI or Fibre Channel) and the available devices. This list can be scrolled with the cursor up/down keys. The first column displays the IO channel ("SCSI" stands for SCSI and "FCAL" for Fibre-Channel). The next column shows the ID followed by the LUN (Logical Unit Number; normally always 0). The next column is either filled with a small "i" (for initialized), or empty. Initialization means the creation of ICP-specific configuration data on the hard disks and the adjustment of hard disk specific operating parameters (protocol, transfer rate, etc.). The next entry lists the vendor and type of device, followed by the drive's attributes (RW for

Select Physical Drive							
Chn	ID	LUN	Vendor	Product	Attr	Cap(MB)	Drive
SCSI-A	0	0	i	QUANTUM ATLAS10K2-TY184J	RW	17509	
SCSI-A	9	0	i	SEAGATE ST39102LC	RW	8682	
SCSI-A	10	0	i	FUJITSU MAF3364LC	RW	34746	
SCSI-A	11	0	i	FUJITSU MAF3364LC	RW	34746	Drive 4
SCSI-A	12	0	i	FUJITSU MAF3364LC	RW	34746	
SCSI-A	7	0		SCSI I/O Processor			
SCSI-B	8	0		SDR, Inc. GEM312 REV001			
SCSI-B	1	0	i	SEAGATE ST39175LC	RW	8682	
SCSI-B	2	0	i	SEAGATE ST39175LC	RW	8682	Drive 6
SCSI-B	3	0	i	SEAGATE ST39175LC	RW	8682	
SCSI-B	4	0	i	SEAGATE ST39175LC	RW	8682	
SCSI-B	15	0	i	QUANTUM ATLAS10K2-TY184J	RW	17509	
SCSI-B	7	0		SCSI I/O Processor			
SCSI-C	14	0	i	QUANTUM ATLAS10K2-TY184J	RW	17509	
SCSI-C	7	0		SCSI I/O Processor			
SCSI-D	0	0	i	QUANTUM ATLAS10K2-TY184J	RW	17509	
SCSI-D	7	0		SCSI I/O Processor			

[- F4: Extended Information, F5: Identify Drive, F8: Repair

Read/Write; RO for Read Only). The IO-Processors and SAF-TE-Processors (in our example channel B ID 8: SDR, Inc. GEM312 REV001) to not have attributes. The next column lists the capacity of the hard disk in MB (1MB = 1024KB; 1GB=1024MB). The last column gives information on the assignment of this Physical Device to a Logical/Array/Host Drive.

With ICP Fibre Channel RAID Controllers, F4 delivers extended information on Fibre Channel drives (World Wide Name, firmware-level and the Link- status of the drive).

If you press F5, the ICP Controller periodically turns the LED (if available) of the corresponding drive on and off. This helps to physically identify a specific drive in an array of many drives.

If you press F8 you can repair the configuration data of a physical drive. If your ICP Controller should ever display during his boot sequence a message like "Detected Primary Configuration Data error, using Secondary" or similar, you can try to repair the data with F8.

If you press ENTER on a specific drive ICPCON opens the "Configure Disk" menu. Here, all relevant adjustments and modifications concerning the physical drives can be carried out.

Note: If you create new Host Drives with the Express Setup function, ICPCON and the ICP Controller will automatically adjust all parameters to their respective best values. The transfer rate per drive depends on circumstances like cables, terminators, etc.. I.e., if a certain configuration does not allow 160 MB/sec, the drive will be automatically "throttled" down to the next trouble-free transfer rate.

Select Physical Drive							
Chn	ID	LUN	Vendor	Product	Attr	Cap(MB)	Drive
SCSI-A	0	0	i	QUANTUM ATLAS10K2-TY184J	RW	17509	
				Configure Disk	LC	8682	
				SCSI Parameter/Initialize	LC	34746	
				Format Disk	LC	34746	Drive 4
				Check Surface	LC	34746	
				View Defects/Status	Processor		
				Deinitialize Disk	REV001		
				Lock Disk	LC	8682	
				Unlock Disk	LC	8682	Drive 6
				Enclosure Status	LC	8682	
				Enclosure Slot Configuration	K2-TY184J	17509	
SCSI-C	7	0		SCSI I/O Processor			
SCSI-D	0	0	i	QUANTUM ATLAS10K2-TY184J	RW	17509	
SCSI-D	7	0		SCSI I/O Processor			

[- F4: Extended Information, F5: Identify Drive, F8: Repair

J.4.4.1 Menu Advanced Setup: Configure Phys. Devs., SCSI Parameter /Initialize

This option can destroy all data on the hard disk.

If a hard disk is not yet initialized, you have to initialize it first. ICPCON copies ICP specific configuration blocks on the hard disk, a primary block and a mirrored secondary block. The possible settings are different if you select a SCSI hard disk or a Fibre Channel hard disk. With a FCAL

Chn	ID	LUN	Vendor	Product	Attr	Cap(MB)	Drive
SCSI-A 0	0	i	QUANTUM	ATLAS10K2-TY184J	RW	17509	
				Configure Disk	LC	8682	
				SCSI Parameter/Initialize	LC	34746	
Fo				Initialize Disk		34746	Drive 4
Ch				Sync. Transfer	(Enabled)	34746	
Vi				Sync. Transfer Rate	(160.0 MB/s)		
De				Disconnect	(Enabled)		
				Disk Read Cache	(On)	8682	
Lo				Disk Write Cache	(On)	8682	Drive 6
Un				Tagged Queues	(On)	8682	
				F4: Advanced Configuration		8682	
				Enclosure Status	K2-TY184J RW	17509	
				Enclosure Slot Configuration	---		
SCSI-C 7	0			SCSI I/O Processor			
SCSI-D 0	0	i	QUANTUM	ATLAS10K2-TY184J	RW	17509	
SCSI-D 7	0			SCSI I/O Processor			

hard disk there are only a few settings which are relevant. You should always check that they are all "Enabled" or "On". If the hard disk you have selected is an Ultra 160 device and the ICP Controller has Ultra 160 SCSI channels, F4 "Advanced Configuration", allows you to configure the so-called "Domain Validation" (a cyclical check of the correct data transfer at a given rate). Normally this parameter is On.

The various settings have the following meanings:

Sync. Transfer: Enabled

The SCSI-bus knows two methods of data transfer: asynchronous and synchronous transfer. Each SCSI device must be able to perform the first type of transfer, the second one is optional. The advantage of the synchronous transfer consists in a higher data transfer rate, since the signal transfer times on the possibly long SCSI-cable have no influence on the transfer rate anymore. Two SCSI-bus participants which want to exchange data between each other have to check if and how (i.e., with which parameters) a synchronous data transfer between them is possible. Therefore, the mere setting does not automatically enable synchronous data transfer; this mode is only effective if both devices support it and after they have checked their capability of communicating with each other in this mode.

Sync. Transfer Rate

This is the synchronous data transfer rate in MB/s. Ultra 160 SCSI allows up to 160 MB/s. If a given SCSI-cable does not allow a certain transfer rate, it can be reduced to a value that allows a trouble-free data transfer. The reason for such a restriction is not necessarily a "bad" SCSI-cable. Lowering the transfer rate may also become necessary when you set up a special configuration which does not allow full speed.

Disconnect: Enabled

The concept of the SCSI-bus allows several participants. It is particularly important to guarantee a high degree of action overlapping on the SCSI-bus. This high degree of overlapping becomes possible when a SCSI device has an enabled "Disconnect".

Disk Read Cache / Disk Write Cache / Tagged Queues

Out of performance reasons, the read ahead and write cache of the hard disk should be always On. Tagged Queues is a SCSI feature which allows the drive to execute more than one command at a time, if available, it should also be On.

If you leave this configuration form with <ESC> and you have made changes, ICPCON displays a security request. The warning of the destruction of all data implies different evaluations, depending on the device's current state and the options you selected:

```
Initialization of disk will destroy all data.
Continue ? (Y/N)
```

First Initialization of the Device. In this case, the warning must be taken seriously. If the drive was previously connected to a different controller (e.g. NCR etc.) and still contains important data, this data will be lost now.

The Device was already initialized. If only internal parameters such as Disconnect, Synchronous Transfer, and Disk Read/Write caches, or tagged queues have been changed, the data on the drive remains intact. Only the function state of the device changes.

J.4.4.2 Menu Advanced Setup: Configure Phys. Devs., Format Disk

This option destroys all data on the hard disk.

All manufacturers of hard disks deliver their products already formatted and surface-tested. For new hard disks it is neither necessary, nor advisable to perform the Format Disk. This procedure is only indicated if you have doubts on the hard disk's condition.

The time required for the Format Disk of a hard disk depends on the hard disk itself. It can take quite a long time (up to days !). Often it seems that nothing happens and that the system hangs (no LED indication). If you put your ear on the hard disk you can hear the actuator stepping (with some drives one step per minute or longer). **Never interrupt a Format Disk procedure.** This may lead with a very high probability to a non-functioning hard disk. Before the actual formatting, ICPCON asks you whether the "Grown Defect" table of the hard disk should be deleted. Some users believe that this makes a hard disk with a lot of grown defects like new. This is wrong. As soon as the bad sectors are accessed again, a re-assign will happen, generating a new grown defect.

J.4.4.3 Menu Advanced Setup: Configure Phys. Devs., Check Surface

This option destroys all data on the hard disk.

This option allows the checking of the surfaces of the hard disk media. The ICP Controller writes and reads certain data patterns and checks them for correctness.

After confirming the security request, a progress information is displayed. You can interrupt the Check Surface option by pressing <ESC>.

J.4.4.4 Menu Advanced Setup: Configure Phys. Devs., View Status/Defects

Grown defects. Number of media defects that have occurred in addition to the media defects the hard disk already had upon delivery.

Primary defects. Number of media defects that the hard disk already had upon delivery.

Last status: The Last Status gives detailed information on the last failure of a hard disk. The information is only present until the next hard reset of the system and may help for deeper failure analysis or tracing.

```
Grown defects: 0
Primary defects: 1358
Last status: 0x00000000
```

J.4.4.5 Menu Advanced Setup: Configure Phys. Devs., Deinitialize Disk

This option destroys all data on the hard disk.

This menu option allows you to de-initialize a hard disk which has previously been initialized for use with the ICP Controller. By doing so, the specific ICP information present on the device is removed. Obviously, the de-initialization cannot restore data that was lost during initialization.

J.4.4.6 Menu Advanced Setup: Configure Phys. Devs., Lock/Unlock Disk

This option is only high-lighted when you have selected a removable hard disk (e.g., Syquest, Iomega). Before you can initialize a cartridge you have to lock it. Before removing it you have to unlock it.

J.4.4.7 Menu Advanced Setup: Configure Phys. Devs., Enclosure Status

After selecting this option you can either view the Enclosure Status or view/configure the enclosure slots. Before you can use the Auto Hot Plug with a SAF-TE subsystem, you first have to configure the subsystem (more precisely it's intelligence, the so-called SEP - SAF-TE Enclosure Processor).

Enclosure Status	
Audible Alarm Status	(Not available)
Door Lock Status	(Not available)
Power supply 0 status	(Operational and on)
Power supply 1 status	(Operational and on)
Fan 0 status	(Operational)
Fan 1 status	(Operational)
Fan 2 status	(Operational)
Enclosure temperature	(OK)
Temperature sensor 0	(33 °C / 91 °F OK)

F10: Refresh Info

To assign a specific hard disk to a SAF-TE enclosure slot, press ENTER on the empty slot and choose one of the hard disks.

Enclosure Slots								
Slot	Chn	ID	LUN	Vendor	Product	Attr.	Cap(MB)	Drive
0	SCSI-A 9	0	i	SEAGATE	ST39102LC	RW	8682	
1	SCSI-A 10	0	i	FUJITSU	MAF3364LC	RW	34746	
2	SCSI-A 11	0	i	FUJITSU	MAF3364LC	RW	34746	Drive 4
3	SCSI-A 12	0	i	FUJITSU	MAF3364LC	RW	34746	
4	SCSI-B 1	0	i	SEAGATE	ST39175LC	RW	8682	
5	SCSI-B 2	0	i	SEAGATE	ST39175LC	RW	8682	Drive 6
6	SCSI-B 3	0	i	SEAGATE	ST39175LC	RW	8682	
7	SCSI-B 4	0	i	SEAGATE	ST39175LC	RW	8682	

ENTER: Add/Remove Disk

The next page shows a block diagram of a SAF-TE subsystem.

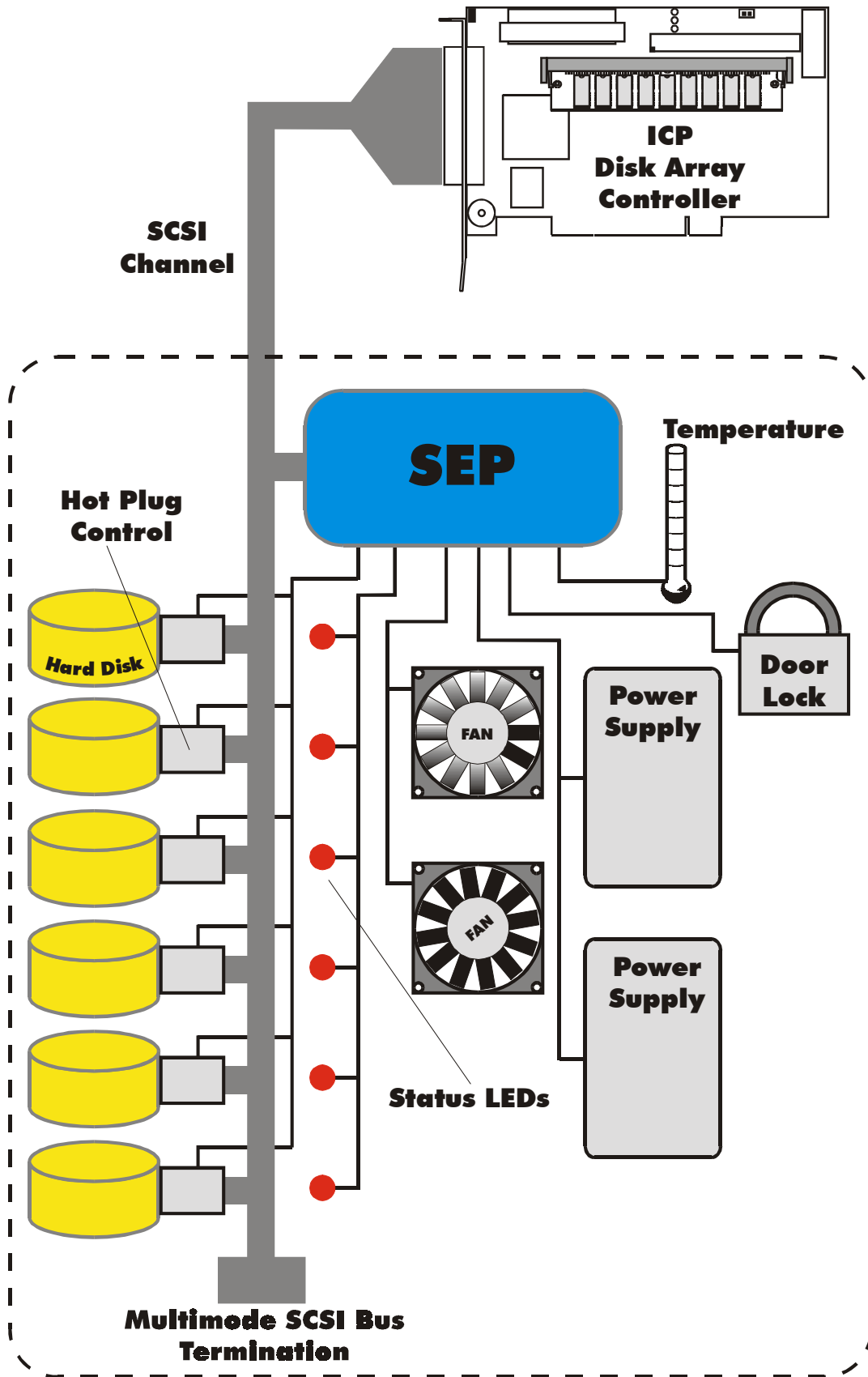

J.4.5 Menu Advanced Setup: Configure Logical Drives

Logical Drives (hierarchy level 2) are installed in this main menu option.

Selecting *Configure Logical Drives* leads you to the screen shown next.

The F4 key gives you a list of all the hard disks this Logical Drive consists of. If it is a Logical Drive of the type **Disk**, it only consists of one single hard disk. If a Logical Drive consists of more hard disks, it is of the type **Chain** (concatenation of several hard disks).

F3 loads the media of removable hard disks and F5 turns for some seconds periodically the hard disks LED on and off.

```

ICP RAID Console -- Version 1.00 - May 30 2000
(C) Copyright 2000 ICP vortex Computersysteme GmbH

Advanced Setup
Configure Controller
Configure Physical Devices
Configure Logical Drives

Select Logical Drive
No. Name      Status      Attr. Capacity Type      belongs to
0 PD_E001    ok          RW      8747 MB Disk      Array 0

Physical Drive(s)
Chn  ID LUN  Vendor Product      Attr Cap(MB) Drive
-----
SCSI-E 1 0 i IBM  DPSS-309170M RW      8747 Drive 0

6 PD_B002    ok          RW      746 MB Disk
254          missing    746 MB ???
Create new Logical Drive
F4: Drive Information, F3: Load All, F5: Identify Drive, F10: Refresh

[PCI 0/1]: GDT7663RN, RAM: 64 MB SDRAM, FW: 2.27.00-RFFF

```

To configure and setup an new Logical Drive, select Create new Logical Drive. ICPCON displays a list of free Physical Drives (which are not already part of a Logical drive).

```

Select Physical Drive
Chn  ID LUN  Vendor Product      Attr Cap(MB) Drive
-----
SCSI-A 0 0 i QUANTUM ATLAS10K2-TY184J RW      17509
SCSI-A 9 0 i SEAGATE ST39102LC RW      8682
SCSI-A 10 0 i FUJITSU MAF3364LC RW      34746
SCSI-A 12 0 i FUJITSU MAF3364LC RW      34746
SCSI-B 1 0 i SEAGATE ST39175LC RW      8682
SCSI-B 3 0 i SEAGATE ST39175LC RW      8682
SCSI-B 4 0 i SEAGATE ST39175LC RW      8682
SCSI-B 15 0 i QUANTUM ATLAS10K2-TY184J RW      17509
SCSI-C 14 0 i QUANTUM ATLAS10K2-TY184J RW      17509
SCSI-D 0 0 i QUANTUM ATLAS10K2-TY184J RW      17509
SPACE: Select/deselect drive, ENTER: End selection

```

If you select one Physical Drive with SPACE and press ENTER, ICPCON suggests to create a SINGLE Drive out of this hard disk.

```

Select Physical Drive
Chn  ID LUN  Vendor Product      Attr Cap(MB) Drive
-----
* SCSI-A 0 0 i QUANTUM ATLAS10K2-TY184J RW      17509
SCSI-A 9 0 i SEAGATE ST39102LC RW      8682
SCSI-A 10 0 i FUJITSU MAF3364LC RW      34746
SCSI-A 12 0 i FUJITSU MAF3364LC RW      34746

Do you want to create a SINGLE Drive from the selected disk(s) ?
(CAUTION: All data will be destroyed !) (Y/N)

SCSI-C 14 0 i QUANTUM ATLAS10K2-TY184J RW      17509
SCSI-D 0 0 i QUANTUM ATLAS10K2-TY184J RW      17509
SPACE: select/deselect drive, ENTER: End selection

```

If you confirm with <Y>, ICPCON allows you to limit the size of the Logical Drive. This becomes interesting when you configure later on an Array Drive with several identical Logical Drives and you want to make sure that you get appropriate spare hard disks in the future. It would be bad luck if the new hard disk would have 17508MB, only. It simply wouldn't fit into the Array Drive. If you limit the capacity to e.g., 17000MB from the beginning, you can be sure that all future 18GB hard disk will have at least 17000MB and thus can be used as spare hard disk.



If you select two or more Physical Drives with SPACE, ICPCON suggest the creation of a Logical Drive of the type *Chain*. In some literature Disk Chaining is also called *Disk Spanning*. You can picture the functioning mechanism of a type *Chain* Logical Drive as follows: all hard disks forming the Logical Drive are linked together one by one in the exact same order in which they have been selected with the SPACE bar. This concatenation can be compared with a chain. If, for example, the Logical Drive consists of 4 hard disks with 2000MB each, the Logical Drive will have a capacity of 8000MB. When data is written to this Logical Drive, the first hard disk is filled first, then the second, and so on. Although it is not advisable, Logical Drives of the type Chain, can also be components of Array Drives.

J.4.6 Menu Advanced Setup: Configure Array Drives

This main menu option allows you to configure Array Drives (level of hierarchy 3). Array Drives with the following listed RAID levels can be configured within this menu.

- RAID 0 pure data striping without redundancy
- RAID 1 disk mirroring
- RAID 4 data striping with dedicated parity drive
- RAID 5 data striping with striped parity
- RAID 10 RAID 0 combined with RAID 1

The ICP Controller can manage up to 35 Array Drives (with different RAID levels) simultaneously. Obviously, the physically existing number of hard disks will limit the number of parallel used Arrays.

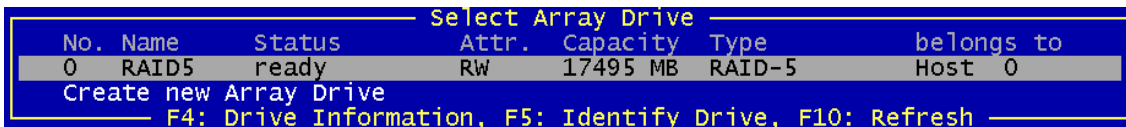

No.	Name	Status	Attr.	Capacity	Type	belongs to
0	RAID5	ready	RW	17495 MB	RAID-5	Host 0

Create new Array Drive
F4: Drive Information, F5: Identify Drive, F10: Refresh

F4 displays level by level detailed information on the selected Array Drive (the structure, the order, which hard disks are part of the Array Drive). With F5 the ICP Controller turns for a few seconds the LEDs of all hard disks belonging to this Array Drive periodically on and off. This may help to identify the hard disks.

If you press ENTER on a specific Array Drive ICPCON displays a list of possible options.

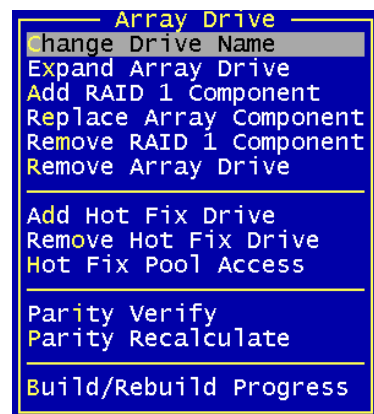

Change Drive Name
Expand Array Drive
Add RAID 1 Component
Replace Array Component
Remove RAID 1 Component
Remove Array Drive
Add Hot Fix Drive
Remove Hot Fix Drive
Hot Fix Pool Access
Parity Verify
Parity Recalculate
Build/Rebuild Progress

J.4.6.1 Menu Advanced Setup: Configure Array Drives, Change Drive Name

This command allows you to change the name of an Array Drive. The name serves to identify an Array Drive in ICPCON or ICP RAID Navigator. This can be very helpful for configurations where several Host Drives of various types are operated by a single controller.

J.4.6.2 Menu Advanced Setup: Configure Array Drives, Expand Array Drive

The *Expand Array Drive* option which is also available with ICP RAID Navigator, contains three major functions:

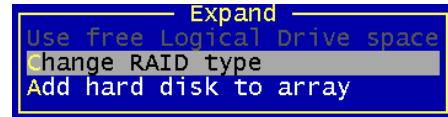

1. *Conversion* of a free space on the Logical Drives into a separate Host Drive
2. *Migration* of the RAID level of a given Array Drive
RAID 0 -> RAID 4 and vice versa
RAID 0 -> RAID 5 and vice versa
3. *Expansion* of the capacity of a given Array Drive

To initiate a migration or expansion with a RAID 4/5 Array Drive, the state must be *ready*. The data on the Array Drive remain intact and are not affected by the expansion. The additional capacity is introduced as new Host Drive. If a Logical Drive fails during the expansion, the expansion process continues until the expansion is finished. The Array Drive changes into the *fail* state.

J.4.6.3 Menu Advanced Setup: Configure Array Drives, Add RAID 1 Component

In certain "emergency" cases this is a very powerful and helpful option. This function allows you to add to a Logical Drive which is member of an Array Drive, another Logical Drive as a mirror drive (RAID-1).

Example: You have configured an Array Drive with 4 Logical Drives. One Logical Drive has failed and the Array Drive went into the fail state. Another failure would cause data loss. Unfortunately, you find another Logical Drive, which is shortly before failing (e.g., you hear a strange noise from it, or it's grown defect counter explodes). If you now initiate a hot plug it is very likely that this critical Logical Drive will also fail. This would result in a disaster. To avoid that problem, you can mirror in a first step a new good Logical Drive to the critical one. When the copying is finished you remove the critical Logical Drive and then carry out a hot plug procedure.

J.4.6.4 Menu Advanced Setup: Configure Array Drives, Replace Array Component

If a Logical Drive of an Array Drive without a Hot Fix drive should fail (or is very likely to fail, soon), you should replace the defective hard disk with a new one as soon as possible because the Array Drive is without redundancy. The replacement Logical Drive has to have at least the same capacity as the failed one. The replacement is carried out either with ICPCON or ICP RAID Navigator. After having installed the replacement hard disk as a new Logical Drive, you can add it to the Array Drive. After selecting the Logical Drive which needs to be exchanged, ICPCON offers a list of existing Logical Drives which can be used as replacement units. The Array Drive's state is changing into *rebuild* and the missing data is automatically reconstructed on the new Logical Drive.

J.4.6.5 Menu Advanced Setup: Configure Array Drives, Remove RAID 1 Component

This option corresponds with the *Add RAID-1 Component* option. It allows you to remove a previously configured RAID-1 combination.

J.4.6.6 Menu Advanced Setup: Configure Array Drives, Remove Array Drive

This command allows you to remove an existing Array Drive.

All the data of the Array Drive will be lost !

Before you confirm the security request with <Y>, you should be sure about this choice.

Do you really want to remove the selected drive ? (Y/N)

Note: If an Array Drive has been removed, it can perhaps be rebuilt without data loss if it is reconstructed in the exact same order it had been built before, if the components of the Array Drive, that is the Host Drives, have not been modified, if the stripe size and RAID level is the same and if a Non-Destructive Build is carried out. In all other cases ALL DATA WILL BE LOST !

J.4.6.7 Menu Advanced Setup: Configure Array Drives, Add Hot Fix Drive

This submenu option allows you to add a Hot Fix drive to an existing RAID 1, RAID 4, RAID 5, or RAID 10 Array Drive. There are two different types of Hot Fix drives: *Private* and *Pool* Hot Fix drives. A *Pool* Hot Fix Drive is a spare drive within the so-called Hot Fix Pool. A drive in a Hot Fix Pool is available for several Array Drives as a Hot Fix drive. Thus, several Array Drives can share one Hot Fix drive. Of course, once this drive has been used by one of the Array Drives, it is no longer available for the others. A *Private* Hot Fix drive is dedicated to one RAID 1, RAID 4, RAID 5 or RAID 10 Array Drive.

Only drives that meet the following requirements are suitable as Hot Fix drives:

1. The Logical Drive that is to become a Hot Fix drive must not be an active component of another Array Drive.
2. The Logical Drive that is to become a Hot Fix drive must have a storage capacity greater than or equal to the storage capacity of the smallest Logical Drive of the Array Drive. Example: A type RAID 5 Array Drive consists of the following components:

Logical Drive 0	2000MB
Logical Drive 1	1500MB
Logical Drive 2	1100MB
Logical Drive 3	2000MB

This Array Drive has a usable storage capacity of 3300MB. A Hot Fix drive for this array must have at least 1100MB of storage capacity. (Note: in order not to waste valuable storage capacity, it is strongly recommended that all Logical Drives forming an Array Drive have the same storage capacity.)

What happens after a drive failure ?

The controller will substitute a failed Logical Drive with a Hot Fix drive only if the Array Drive was in the *ready* state before the failure, or, in other words, a Hot Fix drive can only be activated if the corresponding Array Drive had a state of data redundancy at the moment of failure.

1. After a short while, the controller's alarm turns on.
(Note: the alarm is activated only when the Array Drive is being accessed.)
2. The controller activates the *fail* operation mode. In this mode, the Array Drive remains fully operational. The data located on the failed drive is generated by means of the redundancy information stored on the other drives, without causing any decrease in performance.
3. The controller integrates the Hot Fix drive into the Array Drive and starts to reconstruct the data and redundancy information. The Array Drive is now in the *rebuild* operation mode.

Obviously, no other hard disk may fail until all data has entirely been reconstructed on the Hot Fix drive, because up to that moment, the system is operating without redundancy.

Notes: In some literature, Hot Fix drives are also called *Hot-Spare* drives. You can add or remove Hot Fix drives also with the ICP RAID Navigator.

J.4.6.8 Menu Advanced Setup: Configure Array Drives, Remove Hot Fix Drive

This option allows you to remove a Hot Fix Drive from an existing Array Drive. Naturally, the Hot Fix drive must not be used up so far.

J.4.6.9 Menu Advanced Setup: Configure Array Drives, Hot Fix Pool Access

By selecting the *Hot Fix Pool Access* option, the access of a specific Array Drive to the Hot Fix pool can be enabled or disabled.

J.4.6.10 Menu Advanced Setup: Configure Array Drives, Parity Verify

The redundancy information which is calculated during an array *build* or *rebuild* is stored on a dedicated Logical Drive (RAID 4), or is distributed over all Logical Drives of the Array Drive (RAID 5). This information is often called *parity data*. The calculation is made with an exclusive OR function (XOR). If a Logical Drive of an Array Drive fails, its data can be re-calculated by means of the data present on the other Logical Drives of the Array Drive and the parity data. The *Parity Verify* function allows you to check the consistency of an Array Drive's parity data. The verification may take quite a long time, but you can terminate it by pressing <ESC>.

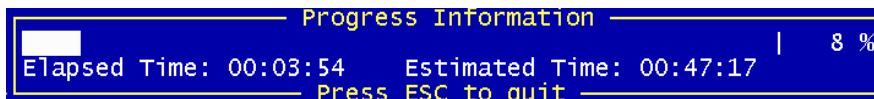

J.4.6.11 Menu Advanced Setup: Configure Array Drives, Parity Recalculate

If the parity information of a given Array Drive is defective, this function may be used to re-calculate it anew.

J.4.6.12 Menu Advanced Setup: Configure Array Drives, Build/Rebuild Progress

Whenever an Array Drive is in the *build* or *rebuild* state, you can select this option, to get progress information and estimates for the required time.

J.4.6.13 Menu Advanced Setup: Configure Array Drives, Create new Array Drive

After pressing ENTER, ICPCON lists all free Logical Drives, which are free (not yet part of Array / Host Drives). The selection bar can be moved with the cursor up/down keys and the Logical Drives can be selected/deselected with the SPACE bar.

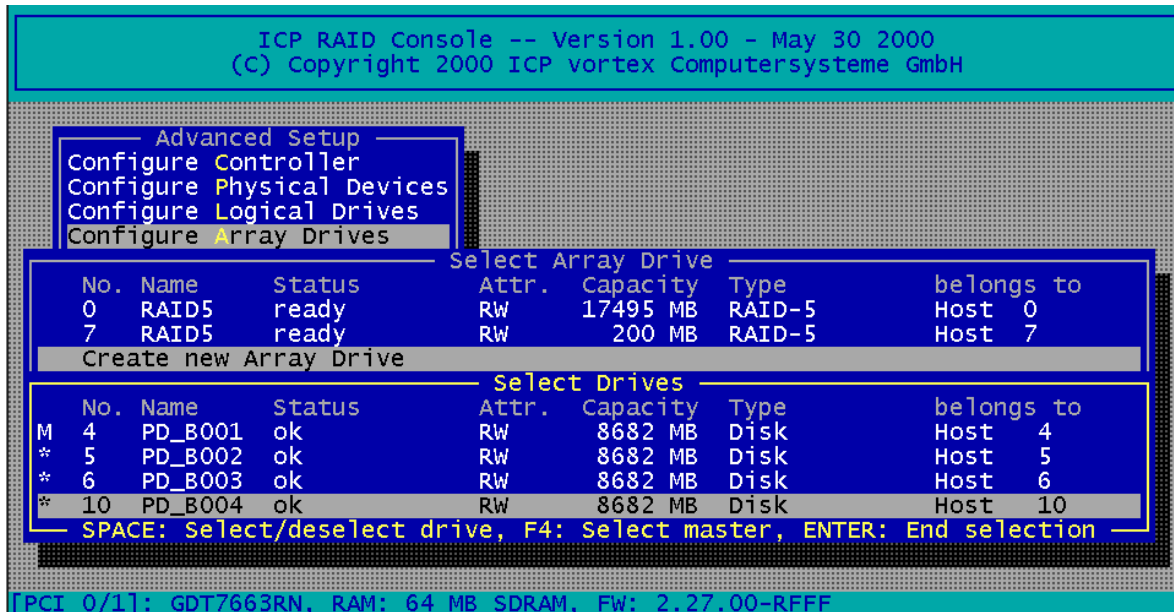

The "M" means Master. For a striping array (RAID 0, 4, 5, 10), this is the first Logical Drive in the array. For a RAID 1 (mirroring) array this is the Logical Drive which contains the valid data and which should be copied to the second Logical Drive. After pressing ENTER

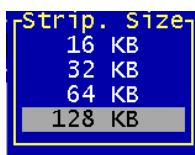

ICPCON displays a list of possible RAID levels. ICPCON will ask you for the Stripe Size. This is the size of the stripes into which the data is divided. Valid values are 16KB, 32KB, 64KB or 128KB. The default is 128KB.

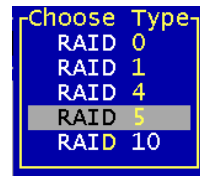

The Build Type decides how the redundancy information is created. The Destructive Build (which is only available if ICPCON was loaded with <CTRL><G>) fills all hard disks with "0" and no further parity calculation is necessary. This build method is pretty fast, but the build must be successfully finished before you can leave ICPCON (otherwise the build mode is automatically changed to Non-destructive during the next boot). The Non-destructive build really calculates the redundancy information from the contents of the data stripes. It takes longer, but can run in the background, i.e., during the installation of the operating system.

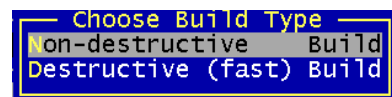

This security request has to be taken seriously. If you confirm with <Y> all data are lost.

Do you want to create a Array Drive from the selected drives ?
(CAUTION: All data will be destroyed !) (Y/N)

If necessary you can limit the Array Drive's capacity. For this example we take the complete capacity.

Drive Size (1..26047 MB): 26047

The Array Drive has entered the *build* state, i.e., the parity information is currently generated. After completion of the build process, the Array Drive's state is *ready*, i.e., fault tolerant.

Select Array Drive						
No.	Name	Status	Attr.	Capacity	Type	belongs to
0	RAID5	ready	RW	17495 MB	RAID-5	Host 0
4	RAID5	build	RW	26047 MB	RAID-5	Host 4
7	RAID5	ready	RW	200 MB	RAID-5	Host 7
Create new Array Drive						
F4: Drive Information, F5: Identify Drive, F10: Refresh						

Notes on the Configuration of RAID 0, 1, 4, 5 and 10 Arrays Drives

(1) Use preferably Logical Drives of the type *disk* to build an Array Drive.

Of course, RAID Array Drives can be configured with Logical Drives of the type *chain*, too, but the aspects of security should be taken into consideration as well. For regular RAID Array Drives, type *disk* Logical Drives are used.

(2) The Logical Drives of an Array Drive should have the same storage capacity.

In order not to waste valuable storage capacity, you should only use Logical Drives that have the same storage capacity for an Array Drive.

(3) The Hot Fix drive provides the utmost security.

One of the reasons for which RAID Array Drives are used definitely lies with the redundancy they provide, that is, the data security you still have even in the event of a hard disk failure, thus resting assured against loss of data and time. For the purpose of the following considerations, we define the term *time without redundancy, TWR*. Set apart the time needed to set up the Array Drive (state *build*), the time without redundancy should be kept as short as possible. Let us assume that one of the hard disks of a RAID 5 Array Drive fails. The Array Drive is without redundancy. TWR starts to run. Any superfluous prolongation of the TWR (because you have to get a replacement hard disk, or because you did not realize the failure immediately since you didn't hear the ICP Controller's alarm signal, or because nobody checked the file server) increases the risk of data loss which will occur if a second hard disk should fail. Therefore, new redundancy should be created as soon as possible and in an entirely automated manner. Integrating a Hot Fix drive as an immediately available and auto-replacing hard disk is the only way to keep the TWR as short as possible. Only a Hot Fix drive can ensure optimal Array Drive security and constant data availability. Of course a Hot Fix drive is not mandatory. If you control the Array Drive at regular intervals and immediately replace a defective hard disk (by shutting down the system or Hot Plug), you can do without a Hot Fix drive.

J.4.7 Menu Advanced Setup: Configure Host Drives

This main menu option allows you to configure Host Drives (level of hierarchy 4). As already mentioned before, these are the drives the Host Computer is aware of. Host Drives can consist of a single hard disk, or of many hard disk combined to a RAID 5 Array Drive. The menus Split/Merge Host Drives and Partition Host Drives are only available if ICPCON was loaded with <CTRL><G> from the ICP Controller's Flash-RAM. The additional capacity resulting from an Online Capacity Expansion is shown as another Host Drive. If you expanded the capacity of the Array Drive a second time, there would be three Host Drives, belonging to one and the same Array Drive. Since there is currently no operating system, which supports "growing hard disks", this expansion method is the only safe way to introduce new capacity.

Host Drive	
change Drive Name	
Swap Host Drives	
Remove Host Drive	

Split Host Drive	
Merge Host Drives	

Partition Drive	
Overwr. Master Boot Code	

Drive Type (cluster)	

J.4.7.1 Menu Advanced Setup: Configure Host Drives, Change Drive Name

This command allows you to change the name of a Host Drive. The name serves to identify a Host Drive within ICPCON and ICP RAID Navigator.

J.4.7.2 Menu Advanced Setup: Configure Host Drives, Swap Host Drives

When the PCI computer is switched on, the Host Drives are initialized in the order of the Host Drive list, which means that the operating system is booted from the Host Drive having the lowest number. For reasons of flexibility, a Host Drive's position in the list can be changed. However, the position of the Host Drive from which the operating system is booted and the position of the Host Drive from which ICPCON (disk version) was started (both can be the same), cannot be changed. If you wish to change the position of these drives, you have to boot the operating system and ICPCON from a floppy disk or use the ICPCON loadable from the Flash-RAM of the controller. To change the position of a Host Drive in the Host Drive list, highlight the Host Drive and confirm with ENTER. Then, type on the new position and press ENTER.

J.4.7.3 Menu Advanced Setup: Configure Host Drives, Remove Host Drives

Removing a Host Drive is a serious action. All data will be lost after removal. If you want to remove a Host Drive belonging to an Array Drive for which several Host Drives exist (after capacity expansion, or after splitting), ALL other Host Drives will also be removed.

J.4.7.4 Menu Advanced Setup: Configure Host Drives, Split Host Drive

For some purposes it might be of interest to split an existing Host Drive into two or several Host Drives. Each Host Drive looks to the operating system just like a single hard disk. Since the new Host Drives have smaller capacities ICPCON has to write new header information on the two Host Drives. **All data will be lost.**

J.4.7.5 Menu Advanced Setup: Configure Host Drives, Merge Host Drives

This function reverses the *Split Host Drive* option. Only such Host Drives can be merged which belong to the same Array Drive or Logical Drive. Since the new Host Drive has a larger capacity ICPCON has to write a new header information on the new Host Drives. **All data will be lost.**

J.4.7.6 Menu Advanced Setup: Configure Host Drives, Partition Host Drives

The partitioning menu has similar functions as the MS-DOS program FDISK. You can create and delete a partition and also change the active partition. MS-DOS can only be booted from an active partition. Just like FDISK, ICPCON can handle primary partitions, extended partitions, and logical drives within the extended partitions.

J.4.7.7 Menu Advanced Setup: Configure Host Drives, Overwrite Master Boot Code

This option creates a valid and consistent master boot record on the selected Host Drive and should be carried out on any new Host Drive on which Windows NT is installed. **Never use it on Host Drives containing valid data. They will be lost.**

J.4.7.8 Menu Advanced Setup: Configure Host Drives, Drive Type (Cluster)

This option allows you to enable a Host Drive for clustering. Before that the shared IO channel(s) of the ICP Controllers have to be also enabled for clustering.

Chapter K

ICP RAID Navigator

K. ICP RAID Navigator

K.1 Introduction

The ICP RAID Navigator (ICPRNAV) is a powerful tool for setting up, monitoring and maintaining mass storage subsystems based on ICP Controllers. Different to ICP RAID Console the ICP RAID Navigator is a pure GUI-style application, designed for the operation under Windows 95, 98, NT and Windows 2000. The main features are:

Setup of hard disks controlled by the ICP Controller

- Setup and initialize Physical Drives, change the SCSI parameters and cache settings.
- Easy setup and installation of single disks or Array Drives consisting of one or more Physical Drives (chaining, RAID 0, 1, 4, 5 or 10).
- Online installation of Host Drives based on a single disk or an Array Drive.

Maintenance and tuning of existing Array Drives, Host Drives and the ICP Controller

- Configure the cache memory.
- Update the controller firmware.
- Change the device parameters.
- Check or recalculate the parity data of RAID 4 and RAID 5 Array Drives.
- Online capacity expansion of Array Drives.
- Split and merge Host Drives.
- Hot Plug. Replace a failed member of an Array Drive.
- Hot Fix. Configure a spare disk for an Array Drive.
- Configure SAF-TE compliant enclosures.

Monitoring of the whole subsystem

- Watch the performance and throughput of virtually every part of the subsystem. Simply drag-and-drop the device on the statistics window.
- Check the hard disks for retries and reassigns (replacements of defective sectors on a hard disk) to trace problems which might become potential in the future.
- Check the grown defect table of the hard disks to replace a defective drive in time.

Remote configuration and maintenance

- Except the Hot Plug function, all of the above features can be accessed via network. You can maintain and monitor a customer's server via the Internet.
- Supported protocols:
 - IPX/SPX
 - TCP/IP
 - NetBIOS
- The access to the ICP Controller can be protected by password. The password is encrypted.

To install the ICP RAID Navigator, use the icptools program on the ICP System CDROM.

K.2 The ICP RAID Navigator "Controls"







K.2.1 The Toolbar

The toolbar can be made visible or hidden by selecting "Toolbar" from the "View" menu:

By clicking on the different buttons you can open and close the windows of the corresponding programs of the ICP RAID Navigator:



The toolbar can be moved away from the top of the RAID Navigator window and is then shown in a small extra window. To place the toolbar back under the menu bar you can double click on the top window bar of the toolbar or drag & drop the toolbar back under the menu bar. You can also place the toolbar on the bottom of the RAID Navigator window.

Icon	Opens / closes	Description
	Select Controller	Select a local or remote ICP Controller for further actions.
	Physical Configuration	Show and/or modify the ICP Controller and device settings.
	Logical Configuration	Show and/or modify the Logical Drive configuration.
	Statistics	Show statistics.
	Events	Show the ICP Controller events.
		Show information on the ICP RAID Navigator.
		Click on this icon and then on the icon you want online help.

K.2.2 The Status Bar

The status bar at the bottom of the main window displays status information on the icon or the menu option the mouse pointer is currently placed on. The status bar can be displayed or hidden by selecting Status Bar from the View menu.



K.2.3 "Window" Menu Commands

These commands allow you to arrange the windows in the ICP RAID Navigator application window or to activate an open window.

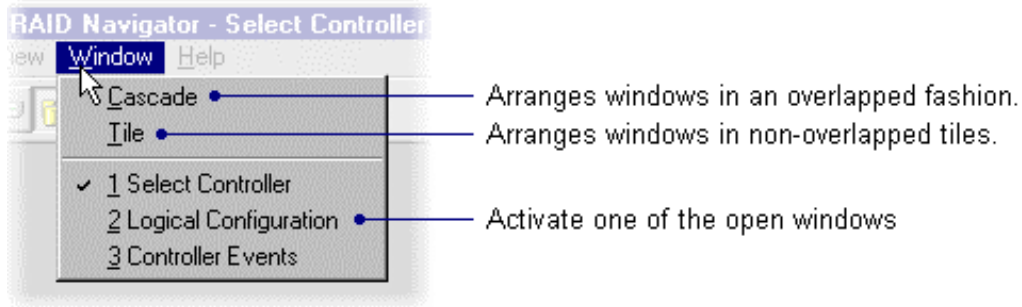

K.2.4 "Help" Menu Commands

The Help menu offers the following commands to provide you with online help:

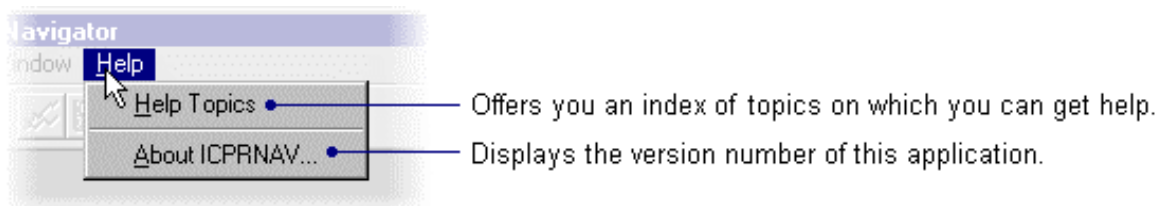

K.2.5 "File" Menu Commands

Here you can end your ICP RAID Navigator session. Shortcuts: Press Alt+F4 or click to close the window.

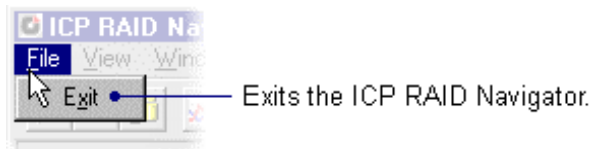

K.2.6 "View" Menu Commands

Use the items in this menu to open or close the windows of the main components of the ICP RAID Navigator or change the appearance of the main window.

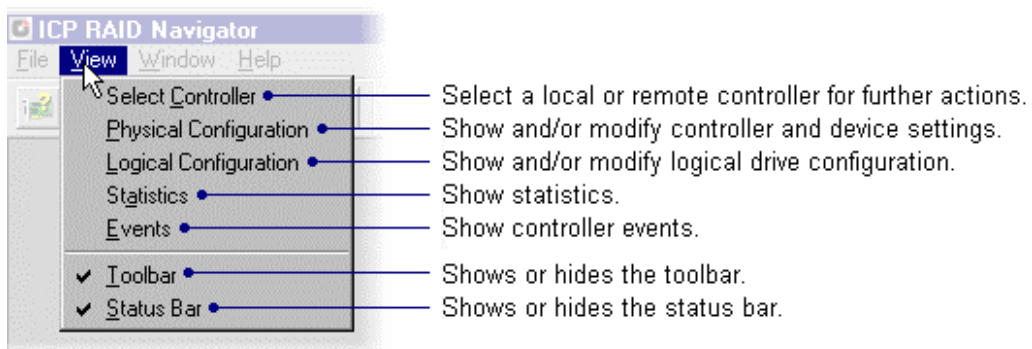

K.2.7 The "Chart" Menu

The chart menu appears when you open the statistics window. Here you can add and remove data sources from the chart and configure the chart.

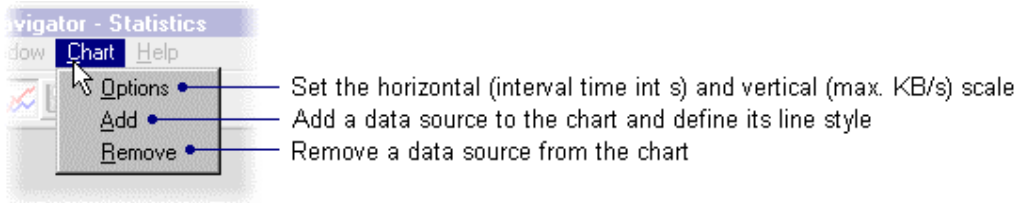

K.2.8 The "Configuration" Menu Commands

This menu appears if you have selected the Physical Configuration window or the Logical Configuration window.

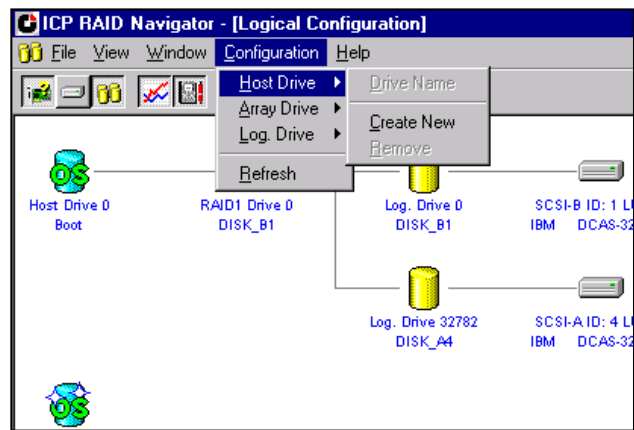
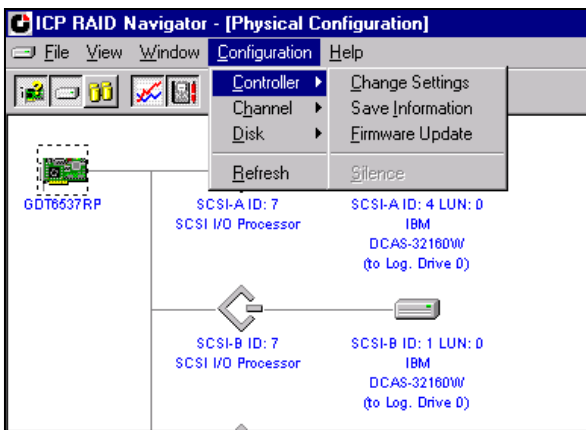

Here you can set the refresh rate for the Physical or the Logical Configuration windows. This is the rate, which is used by the ICP RAID Navigator to update the contents of the physical and logical configuration windows.

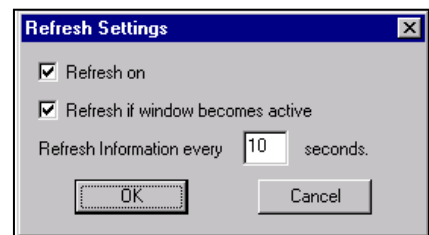

The options are:

Refresh on	Activates and deactivates the window update.
Refresh if window becomes active	Update the window if it becomes active.
Refresh information every ... seconds	Sets the frequency for automatic window refreshes.

The menu options you can select here are also available if you click the right mouse button on the corresponding icon in the Physical or the Logical Configuration windows.

K.3 Select Controller

This window is used to select an ICP Controller for all further actions within the ICP RAID Navigator.

In a first step you should select the desired protocol (Windows NT/95/98, Sockets, IBM NetBIOS) for the communication between the ICP RAID Navigator and the system which is equipped with the ICP Controller by double clicking on the protocol icon on the very left side of the window. If you want so select an ICP Controller via TCP/IP (sockets), type in the corresponding TCP/IP address or the server system's name. You are then asked to enter a user name and a password. This information is transmitted with encryption.

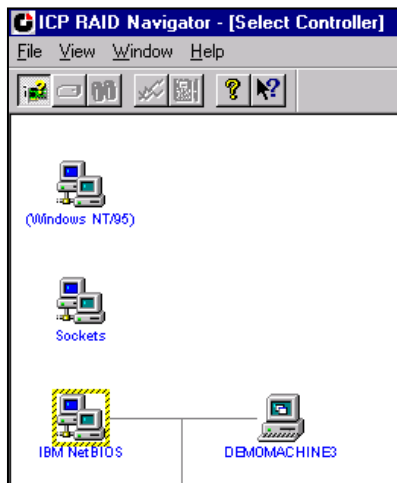
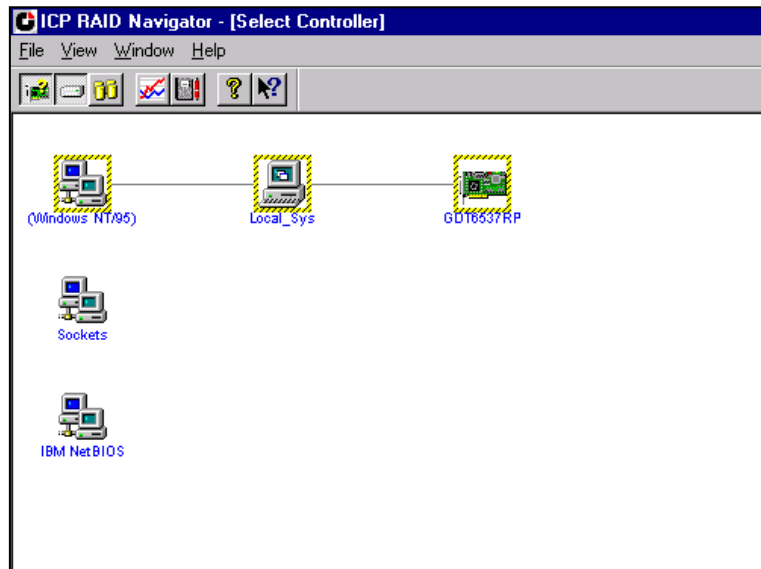

After the protocol was selected, select the system which contains the ICP Controller and afterwards the ICP Controller itself. The selection and de-selection is done by double clicking on the ICP Controller. The selected protocol, system and ICP Controller are shown in a dashed yellow frame.

No more action can be done in this menu.

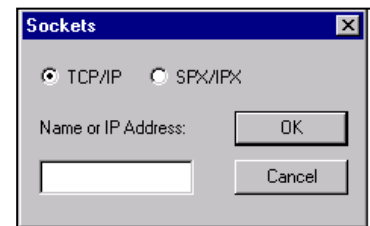

K.4 Physical Configuration Window



This window shows the physical configuration of the SCSI or Fibre Channel busses of the selected ICP Controller and the devices connected with these busses. The complete configuration is shown as a tree starting from the left with the ICP Controller.

To get detailed information on the single devices, double click on the icons. The windows that open, depend on the type of the selected device.

To change the physical configuration of the devices, click the right mouse button on the desired device or select the corresponding item from the Configuration menu. Possible choices are (Click on the popup menu items to get information on them):

K.4.1 Controllers

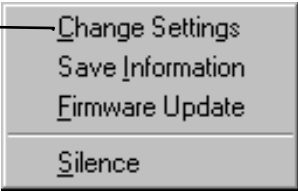
Icon	Description	double click opens...	right click opens...
	Controller	Controller Information	 <ul style="list-style-type: none"> Change Settings Save Information Firmware Update Silence

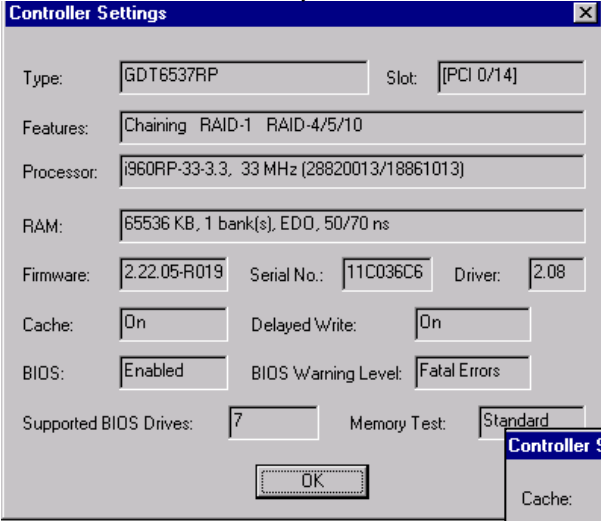

Controller Settings

Type: Slot:

Features:

Processor:

RAM:

Firmware: Serial No.: Driver:

Cache: Delayed Write:

BIOS: BIOS Warning Level:

Supported BIOS Drives: Memory Test:



Controller Settings

Cache: Off On

Delayed Write: Off On

BIOS: Removed Enabled Disabled

BIOS Warning Level: All Messages Fatal Errors

Supported BIOS Drives: 2 7

Memory Test: No Test Standard Double Intensive

Change Settings

Here you can change the settings of the ICP Controller.

Cache	Enables or Disables the ICP Controller cache. For optimum performance the cache should be always On.
Delayed Write	Enables or disables the write cache function of the ICP Controller cache. For optimum performance the write cache should be always On.
BIOS	The BIOS of the ICP Controller is needed to boot the computer and the operating system from a Host Drive.
BIOS Warning Level	Enables or disables the display of non-critical boot messages of the ICP Controller during the system boot phase.
Supported BIOS Drives	Adjust the number of Host Drives which are supported by the ICP Controller's BIOS. This is the number (2 or 7) of Host Drives which are available under DOS without loading a special driver.
Memory Test	Configures the strategy and duration of the ICP Controller cache memory test during the boot phase. A more intensive test requires more time.

Save Information

After the selection of this option a file dialog is opened, which allows you to specify the path and name of the Save Information file. This file has a standard ASCII format and can be viewed or printed with a normal editor (e.g., notepad) or word processing system.

The Save Information file contains all relevant information on the ICP Controller (including firmware version, cache size, connector assignment, termination assignment), the connected devices (e.g., firmware version, SCSI parameters, selected transfer rate, number of grown defects, last status information), the Logical Drives, Array Drives and Host Drives. Thus, it represents a very easy and effective way to create a detailed documentation of the ICP Controller(s) and disk array(s).

The Save Information file can also be very helpful for a remote diagnosis of a system. If a trained support person has a copy of this file (by fax, by email), she/he can very easily find the appropriate steps to bring the system back to full operation.

Update the ICP Controller Firmware

The firmware, the BIOS and ICPCON of the ICP Controller are stored in a Flash-RAM which is part of the ICP Controller hardware. In contrast to EPROMs, Flash-RAMs can be re-programmed many times and without the complicated UV-light erasing procedure. Thus, both software modules can be easily updated without having to remove the controller from its PCI slot. Firmware and BIOS are part of the GDT_RPFW file.

To get the latest firmware for your ICP Controller, you can visit our website at

<http://www.icp-vortex.com>

or our ftp server at:

<ftp://ftp.icp-vortex.com/download>

The file has an extension (e.g., GDT_RPFW.009) which indicates the version stepping. We recommend that you also download the packed files which contain the latest programs/drivers for the operating system used on your system. Observe the following order when carrying out the updating procedure:

- Get the latest GDT_RPFW file for the ICP Controller. The file does NOT need to be expanded !
- Format a 3.5" HD disk (1.44MB) and copy the GDT_RPFW file on this disk.
- After selecting the Firmware Update option a file dialog opens where you should specify the path (A:). A list of firmware versions (normally only one) is displayed. After selecting the new firmware and final confirmation, the new firmware is programmed into the Flash-RAM of the ICP Controller.

The new firmware becomes active after the next cold boot.

Note: All user specific settings concerning the ICP Controller and the disk arrays are not affected by the firmware update.

Turn off the Audible Alarm

This option allows you to turn off the audible alarm of the ICP Controller manually. After a significant event (a drive failure or an overheat of the ICP Controller) the audible alarm of the ICP Controller is turned on. If the reason of the event is removed, the audible alarm turns off automatically.

If a member of an Array Drive has failed you should replace the failed drive as soon as possible. Read more about the fail state.



If the state of an Array Drive changes into error (more than one drive has failed) please contact our hotline for further assistance.

If no drive failed, you may also check the Controller Events to find out if the CPU of the ICP Controller is overheated.

If you hear an audible alarm, but the silence function is not offered and there are no critical controller events, check, if the alarm is coming from a different source, like the CPU cooler or the mainboard.

K.4.2 I/O Processors

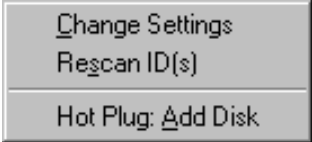
These are the I/O processors of the ICP Controller. Each processor controls one I/O channel.

Icon	Description	double click opens...	right click opens...
	SCSI processor SE (single ended)	Channel Information	 <ul style="list-style-type: none"> Change Settings Rescan ID(s) Hot Plug: Add Disk
	SCSI processor LVD/SE (low voltage differential / single ended)		
	FC processor FC AL (fibre channel arbitrated loop)		

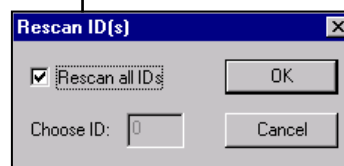
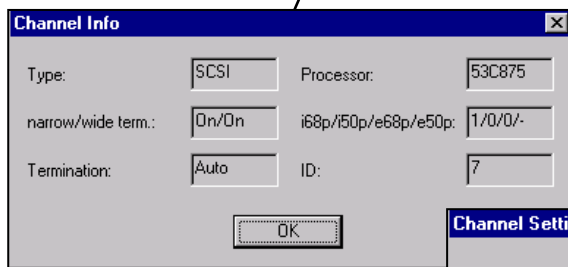

Channel Settings

Termination

The termination for this channel of the ICP Controller can be set to three different states:

- ON: The termination of the lower (low byte) and upper data lines (high byte) is enabled or disabled depending on the occupied SCSI connectors of this channel.
- OFF: No lines are terminated
- AUTO: All 8/16 data lines are terminated.

ID

Changes the SCSI ID of the SIOP (0-7).

Warning: The SCSI bus termination of The ICP Controller must match the existing SCSI cabling and cable termination. If the ICP Controller represents one end of the SCSI bus its termination must be ON or AUTO. If you change the termination to OFF, it is very likely that the SCSI bus is longer stable and the connected devices fail. Due to the different technology, these settings cannot be changed with an FC I/O processor (**fibre channel**).

Rescan ID(s)

This function allows you to rescan one or all IDs of the selected SCSI channel. It displays an overview of all powered SCSI devices which are currently connected with the SCSI bus.

Warning: If the hard disk contains valid Host Drive or Array Drive information, they will be deleted when creating a new Logical Drives. All data will be lost.

Hot Plug: Add Disk



With this Hot Plug function you can add a new hard disk while the system is running. Before starting the Hot Plug procedure, you should prepare the new hard disk and set the jumpers according to the free SCSI IDs and SCSI bus termination. Thus, pay attention to the correct termination of the SCSI bus and set the ID of the hard disk to a free address, if that is not done automatically by your storage subsystem. If you do not know, which IDs are in use on the selected SCSI channel, you can find this out in the physical configuration window. Wrong SCSI bus termination and/or SCSI ID conflicts will cause a failure of the complete SCSI channel. During the Hot Plug procedure firstly enter the ID of the new hard disk (all free IDs are offered). Secondly, you have to confirm a security request. Thereafter the SCSI channel is halted. While the channel is halted, you have 45 seconds to plug in the new hard disk. (Note: Since the operating system will timeout, the channel cannot be halted longer). If you do not complete the Hot Plug procedure manually, the channel will automatically start again after 45 seconds. After the successful completion of the Hot Plug, the new Physical Drive appears in the physical configuration window. Now, you can use it to build a new Host Drive, replace a failed drive or for the expansion of an existing Array Drive. You should only use the Hot Plug function with servers and/or subsystems which are designed and certified for hot plugging of hard disks.

Warning: If the new plugged in hard disk contains valid Host Drive or Array Drive information, they will be deleted when creating a new Logical Drives. All data will be lost.

K.4.3 Direct Access Devices

Direct access devices can be initialized and subsequently used for Logical Drives. The ICP Controller caches the I/Os of these devices. Logical Drives are the components of Array Drives.

Note: If you want change the media of a removable disk during operation, the media **MUST NOT BE INITIALIZED** with ICP RAID Console (ICPCON) or the ICP RAID Navigator. Furthermore these devices have to be reserved for the raw service. Thus, the removable disk is handled like a non direct access device.

Icon	Description	double click opens...	right click opens...
	Physical Disk	Physical Drive Information	<div style="border: 1px solid gray; padding: 5px;"> SCSI Parameter/Initialize Format Disk Check Surface Deinitialize Disk Progress Information <hr/> Lock Disk Unlock Disk <hr/> Hot Plug: Remove Disk </div>
	Removable Disk		

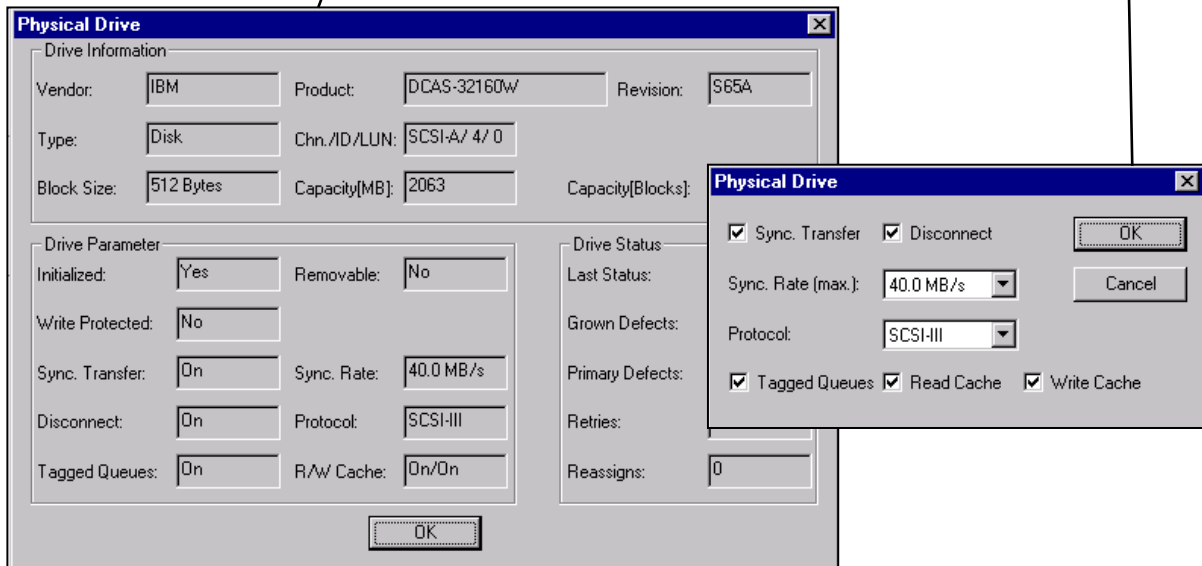

The SCSI Parameters

The SCSI parameters configure a Physical Drive (especially its performance). By changing the SCSI parameters, you can

- set the synchronous transfer rate
- change the settings of the hard disk cache
- enable or disable the disconnect feature
- enable or disable the tagged queues

Warning: By changing these parameters on a new hard disk or a hard disk, which has been connected with a non ICP Controller, this hard disk will be initialized and all data on this hard disk will be lost.

You can access the change SCSI Parameters / Initialize menu by clicking the right mouse button on a Physical Drive in the Physical Drives Windows (View > Physical Configuration)

Synchronous Transfer

Different to the older asynchronous transfer mode, the synchronous transfer offers higher transfer rates on the SCSI bus. The maximum synchronous data transfer rate depends on the width of the SCSI bus (8 bit narrow SCSI, 16 bit wide SCSI) and the frequency of the signals on the SCSI bus (10 MHz for Fast SCSI, 20 MHz for Ultra SCSI and 40 MHz for Ultra2 SCSI and Ultra 160 SCSI). The maximum data transfer rates are:

	Narrow SCSI (8Bit)	Wide SCSI (16Bit)	
Fast SCSI	10 MB/s	20 MB/s	
Ultra SCSI	20 MB/s	40 MB/s	
Ultra2 SCSI	-	80 MB/s	(LVD SCSI (low voltage differential) only)
Ultra 160	-	160 MB/s	(LVD SCSI (low voltage differential) only)

Note: The maximum synchronous data transfer rate between a SCSI device and the ICP Controller can be limited. This limitation may become necessary if a particular SCSI cabling does not allow the maximum rate the controller and the drive could achieve. The adjustment of the synchronous transfer rate can be done in the SCSI parameters / Initialize menu. Notes: In order to select a transfer rate above 10 MB/s the protocol has to be set to SCSI-III. Higher frequencies (single ended SCSI) require better cabling, shorter cables and a professional termination of the SCSI bus.

Disconnect

This SCSI feature enables a SCSI device to disconnect from the SCSI bus. By releasing the SCSI bus while the device doesn't need it, the bus becomes free for other devices to transfer or receive data. An example for a disconnect situation is a hard disk that needs time to read data from its media after receiving a read command. It may then disconnect from the SCSI bus so that other devices can transfer data. Later on it reconnects when it is able to deliver the data instantly. You can change the disconnect setting for a hard disk in the SCSI parameters / Initialize menu.

Tagged Queues

This feature enables modern hard disk drives to receive several commands at one time and then process them in an optimized order. Few, mainly older drives, do not or not correctly support this feature. You can change the tagged queues setting for a hard disk in the SCSI parameters / Initialize menu.

SCSI read cache / SCSI write cache

These settings enable or disable the write and read caches of the hard disks. Turning these caches off degrades the performance of the hard disk. You can change the cache settings of a drive in the SCSI parameters / Initialize menu.

Format a Physical Disk

Caution: This function deletes ALL DATA on the selected Physical Drive !

The hard disk which you want to low level format, may not be member of a Logical Drive if you want to start a low level format or a check surface. This function sends a format unit command to the Physical Drive. Everything else is done by the drive itself. The ICP Controller stands by to receive a good status back from the drive when it has successfully finished the low level format, thus no progress information can be shown. What the drive exactly does during the low level format and how long it takes depends on the manufacturer's format unit command implementation in the firmware of the drive, the speed and capacity of the drive. A low level format can take from seconds to hours or even days. Before you confirm to start the low level format, you are asked if you want to delete the grown defect list of the drive. Deleting this list, does not mean that the grown defects (media defects) vanish. It is very likely that the low level format will trace them again and map them out. Usually, there is no need to low level format a drive. This should be only done with a defective drive. If you want to check the surface of a hard disk, it is better to use the check surface function.

Warning: It is strongly recommended not to interrupt a low level format of a drive. This may cause an inoperable drive.

Deinitialize a Physical Disk





Deinitializing a Physical Drive removes the ICP initialization sectors. The Physical Drive may not be member of a Logical Drive if you want to deinitialize it.

Lock / Unlock a Removable Disk

With this function you can lock or unlock a removable drive containing a removable medium. If the Physical Drive is locked, the medium cannot be ejected with the eject button while the system is running.

K.4.4 Non direct access devices (raw devices)

Non direct access devices cannot become components of Logical Drives, Array Drives or Host Drives. These devices are either controlled by a software driver (e.g. an ASPI module), the operating system or an application. Non direct access devices cannot be initialized or changed in their SCSI parameters with this program.

Icon	Description	double click opens...	
	CDROM / CDR	Physical Drive Information	
	Tape drive		
	SAF-TE-Processor		
	Scanner		
	SCSI Printer		

Example for a Physical Configuration and the Controller Settings:

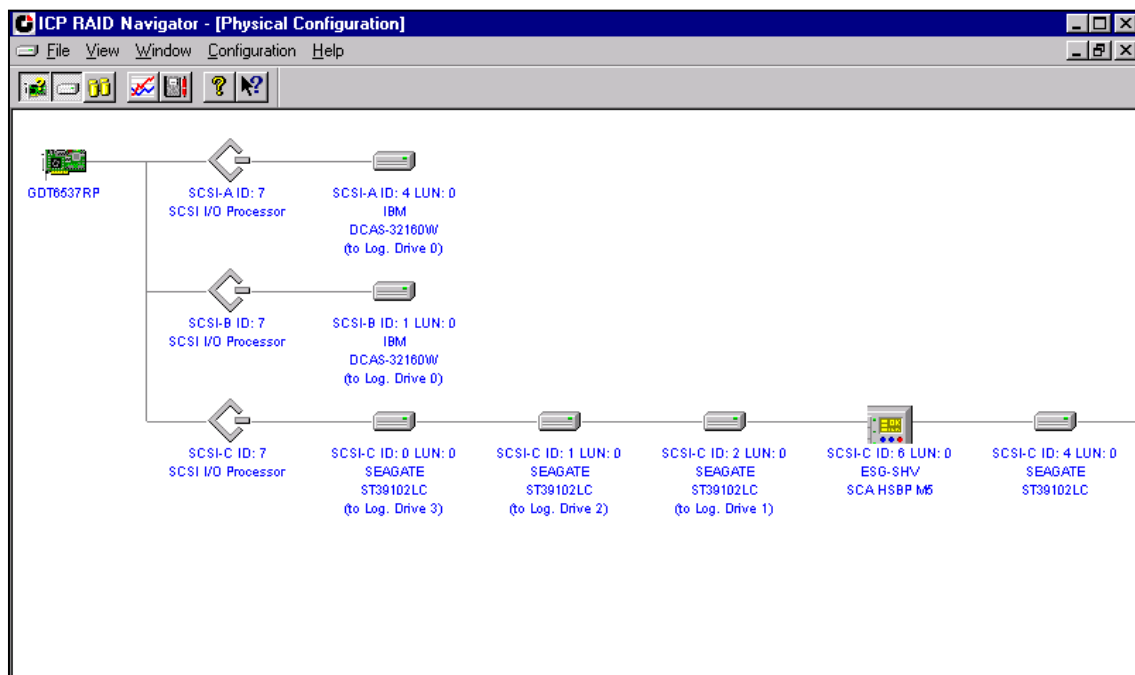

K.5 Logical Configuration Window





This window shows the logical configuration of Host Drives, Array Drives and Logical Drives controlled by the selected ICP Controller. The complete configuration is shown as a tree starting from the left with the Host Drives, followed by the Array Drives (if RAID is configured), the Logical Drives and the Physical Drives. To get detailed information on the single devices, double click on the icons. The windows that will open then, depend on the type of the device.

To change the logical configuration of the drives, click the right mouse button on the desired drive or select the suitable option from the configuration menu.

Host Drives

These are the drives "visible" to the operating system.

Icon	Description	double click opens...	right click opens...
	Host Drives	Host Drive Information	<div style="border: 1px solid gray; padding: 5px; width: fit-content;"> <p><u>D</u>rive Name</p> <p><u>C</u>reate New</p> <p><u>R</u>emove</p> </div>
	Create a new Host Drive	Create a new Host Drive	



Normal Host Drive

This Host Drive belongs to the selected ICP Controller on a non clustering I/O channel.



Local mounted Cluster Drive

A Cluster Drive is a Host Drive on a clustering I/O channel.

This Host Drive is mounted on the selected ICP Controller.

Clustering means that two or more servers share resources. In case of one server failing these resources move over to another valid server. The hard disks used for clustering are physically not connected with just one ICP Controller, but with several ICP Controllers in different servers (shared I/O channels).

Only one server can own a Host Drive at the same time, so a Host Drive configured for clustering may either be controlled by the selected ICP Controller (i.e., local mounted) or by a different ICP Controller (i.e., remote mounted).

You may only change the configuration of a local mounted Host Drive.



Remote mounted Cluster Drive

A Cluster Drive is a Host Drive on a clustering I/O channel.

This Host Drive is mounted on an ICP Controller in a different server.

Clustering means that two or more servers share resources. In case of one server failing these resources move over to another valid server. The hard disks used for clustering are physically not connected with just one ICP Controller, but with several ICP Controllers in different servers (shared I/O channels).

Only one server can own a Host Drive at the same time, so a Host Drive configured for clustering may either be controlled by the selected ICP Controller (i.e., local mounted) or by a different ICP Controller (i.e., remote mounted).

You may only change the configuration of a local mounted Host Drive.



Private Host Drive belonging to another ICP Controller

This is a Host Drive on a clustering I/O channel.

This Host Drive is configured as a Private Host Drive and does not belong to the selected ICP Controller.

Clustering means that two or more servers share resources. In case of one server failing these resources move over to another valid server. The hard disks used for clustering are physically not connected with just one ICP Controller, but with several ICP Controllers in different servers (shared I/O channels).

Usually, when booting a cluster, the ICP Controller starting up first will gain control over all Host Drives on the clustering I/O channels. If you want to be sure that a Host Drive is controlled by a specific server, you may configure this Host Drive as a Private Host Drive. A Private Host Drive cannot be used for clustering anymore.

Note: You cannot change the configuration of a Private Host Drive which is not property of the selected ICP Controller. You have to use ICPCON to change its configuration.





A Private Host Drive belonging to the selected ICP Controller will be displayed like a normal Host Drive.

Array Drives

Array Drives or RAID drives consist of Logical Drives. They can be fault tolerant, depending on the RAID level. The RAID level is displayed under the Array Drive icon.





Click on the icons to get more information on the different states of an array.

Icon	Description	double click opens...	right click opens...
	RAID 4/5/10	Array Drive Information	
	Idle		
	Build		
	Ready		
	Fail		
	Error		

  	RAID 1		
	Build		
	Ready		
Fail			
	RAID 0		

Logical Drives

Logical Drives consist of one or more Physical Drives.

Icon	Description	double click opens...	right click opens...
	Single Disk	Logical Drive Information	
	Hot Fix Drive		
	Failed / missing Hot Fix or Single Disk		
	Chaining Drive		

Physical Drives

These are the hard disks. You cannot change any settings here. If you want to change the settings, you have to do this in the physical configuration window.

	Physical Disk	You can't change the disk settings here. Use the Physical Configuration window instead.
---	---------------	---

K.5.1 The Host Drive Information Window

Double click on the Host Drive icon.

This window contains information on a Host Drive like the Host Drive's capacity and a possible partition table.

Drive No	The Host Drive number of the Host Drive. The Host Drives are reported to the system one after the other, beginning with the lowest Drive Number. If the corresponding ICP Controller is the first controller in the system, the system will boot from the Host Drive with the lowest number.
Name	The name of the Host Drive. A Host Drive is automatically given a name during the configuration. It can be renamed by selecting the menu Drive Name of the menu list you get after clicking with the right mouse button on the Host Drive icon.
Capacity	The capacity reported to the operating system. The size of a Host Drive can be smaller than the size of the Logical Drive or the Array Drive the Host Drive is a part of.
Partition Table	The partition table of a Host Drive can contain up to four partition entries. Information on the type of the partition, it's location on the Host Drive, it's size and the percentage of space used by this partition are shown.

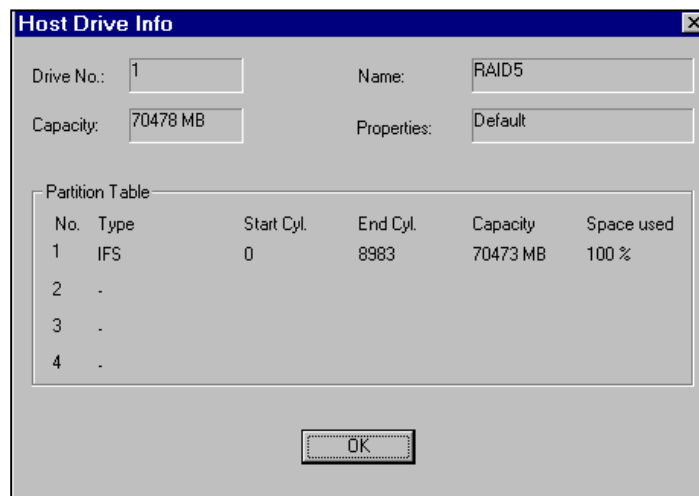

K.5.2 The Array Drive Information Window

Double click on the Array Drive Icon.

This window shows information on an Array Drive (i.e., a disk array).

Drive No	The logical number of the Array Drive.
Drive Name	The name of the Array Drive.

Type	This is the RAID level of the Array Drive. It can be RAID 0 (data striping, no redundancy), RAID1 (mirroring), RAID 4 (striping with parity drive), RAID 5 (striping with striped parity) or RAID 10 (combination of RAID 1 and RAID 0).
Status	The status of an array can be ready (operational), fail (one drive missing, still operational but not redundant), error (more than one drive failed, not operational), rebuild (one drive is being integrated), build (initial preparation of the array), idle (new defined array, before build process has started), expand (one or several drives are added online to the Array Drive).
Capacity	This is the capacity available for the corresponding Host Drives.
Attributes	The attribute of an Array Drive is usually read/write ([RW]). If a component of a disk array is missing while startup and the operator decides not to activate fail mode, the array is set to the read only attribute ([RO]). When the missing drive is available again, the Array Drive shows again the ready status (i.e., attribute [RW]).
Striping Size (RAID 0, 5, 10)	Data written on RAID 0, 4, 5 or RAID 10 drives is distributed over all drives (striping). This is the size of the blocks. The striping size can only be changed when the drive is created (standard setting is 32KB).
Invalid/Missing (RAID 1)	These two values show the number of invalid/missing drives. While the build is in progress (initial copy of data from the Master to the Slave), invalid drives exist (the drives are updated).
Pool Hot Fix	Indicates, if the Pool Hot Fix access is enabled or disabled. A Pool Hot Fix Drive is a spare drive within the so-called Hot Fix Pool. A drive in a Hot Fix Pool is available for several Array Drives as a Hot Fix drive (assuming it has an appropriate capacity). Thus, several Array Drives can share one Hot Fix drive. Of course, once this drive has been used by one of the Array Drives, it is no longer available for the others. Hot Fix Drives can also be configured as Private Hot Fix Drives. A Private Hot Fix Drive can only be used by the Array Drive it was configured for. The Pool Hot Fix access can be changed by clicking with the right mouse button on the Array Drive icon.

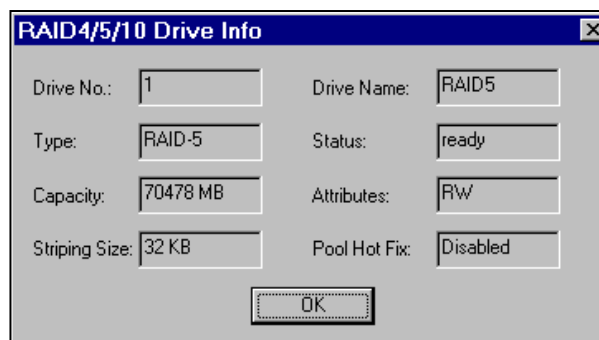

K.5.3 The Logical Drive Information Window

Double click on the Logical Drive icon.

This window shows information on a Logical Drive. A Logical Drive can be either a single disk, or a chaining group of disks (concatenation), or a stripe set of several disks.

Drive No	The number of the Logical Drive.
Drive Name	The name of the Logical Drive.
Type	The type of the Logical Drive. A Logical Drive can be either a single disk, or a chaining group of disks (concatenation), or a stripe set of several disks.
Status	This is the state of the Logical Drive. It can be ready, missing (not available after reset) or failed (i.e., no longer available for the controller).
Capacity	The capacity which is available for Array Drives or Host Drives.
Attributes	The attribute of a Logical Drive is usually read/write ([RW]). If a component of a disk array is missing while startup and the operator decides not to activate fail mode, the array is set to the read only attribute ([RO]). When the missing drive is available again, the Array Drive shows again the ready status (i.e., attribute [RW]).
Last Status	The last status information of a Logical Drive. This is different to the last status information of Physical Drives.
RAID 1 Component	If the Logical Drive is a member of a RAID 1 array, it can be either master or slave. If a RAID 1 component is added to a Logical Drive, the data is read from the master and written to the added Logical Drive (the slave). One master may have several slaves.
RAID 4/5 Component	As a member of a RAID 4 or RAID 5 array a Logical Drive can be the master or a component. Different to RAID 1 arrays, this is only important for the internal structure of the array.

The screenshot shows a window titled "Log. Drive Info" with the following fields and values:

- Drive No.: 1
- Drive Name: DISK_A1
- Type: Disk
- Status: ok
- Capacity: 35239 MB
- Attributes: RW
- Last Status: 0
- RAID1 Component:
 - Type: ---
 - Status: ---
- RAID4/5 Component:
 - Type: Master
 - Status: ok

An "OK" button is located at the bottom center of the window.

K.5.4 Change the name of a Drive

Click the right mouse button on the drive icon.

This menu option opens a dialog where you can enter a new name for the selected drive (up to 7 characters).

K.5.5 Remove a Host Drive

Click the right mouse button on the Host Drive icon. By selecting this menu item you can delete a Host Drive.

CAUTION !

By deleting a Host Drive, all other Host Drives which are part of the same Array Drive or Logical Drive, the Array Drive or Logical Drive itself and all its components are deleted ! ALL DATA WILL BE LOST.

To prevent the operating system from crashing and to hinder the unintentional deletion of drives all partitions on the Host Drive (and it's related Host Drives if it is split into several Host Drives) must be deleted before the Host Drive can be removed.

K.5.6 Create a new Host Drive

Double click on the new Host Drive icon. Only the Host Drives are "visible" for the operating system.

The structure of the Host Drives is not known to the operating system i.e., the operating system does not recognize that a given Host Drive consists of a number of hard disks forming a disk array. To the operating system this Host Drive simply appears as one single hard disk with the capacity of the disk array. This complete transparency represents the easiest way to operate disk arrays under any operating system, neither operating system nor the computer need to be involved in the administration of these complex disk array configurations. To create a new Host Drive, you need one or more Physical Drives which are not yet part of another Host Drive. After double clicking on the New Host Drive icon a new window opens.

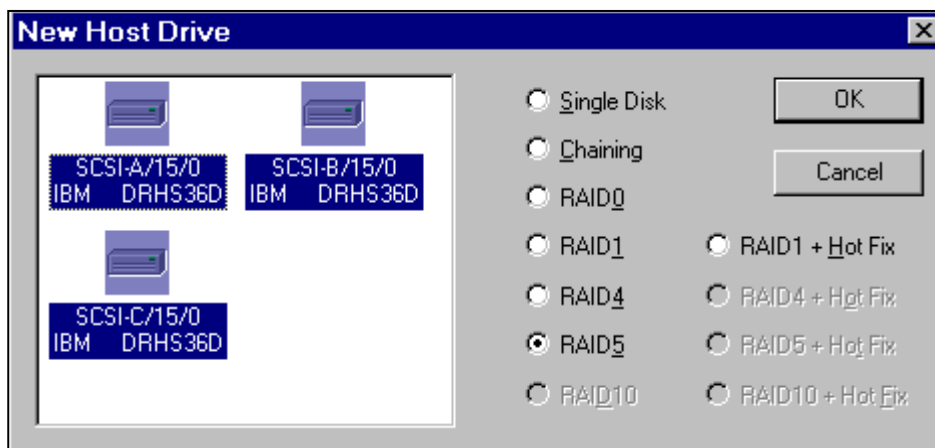

On the left side you see a box with the available Physical Drives, under the drives you can see their physical coordinates (channel/ID/LUN), the manufacturer and the vendor-unique name. On the right side you see a list of all possible Host Drive types which can be configured. When there is no Physical Drive selected in the left box, all possibilities are disabled

(gray). While you are selecting Physical Drives for the new Host Drive, more and more possibilities become selectable.

You can select a single Physical Drive by clicking on it. If you want to select more than one Physical Drive, simply draw a frame around the Physical Drives, or press the <ctrl> key and then click on all the Physical Drives you want to combine to a new array.

When you have finished the selection of the Physical Drives, choose the type of Host Drive you want to create and click on OK.

If the selected Host Drive uses data striping (RAID 0, 4, 5 or 10) you can change the default striping size. If you have selected a configuration with Hot Fix Drives, you can choose between a Private Hot Fix Drive or a Pool Hot Fix Drive. After the Host Drive was created, you can partition and format the Host Drive with the corresponding operating system utility.

If an array build started, you can monitor the progress of the array build by clicking the right mouse button on the Host Drive and then selecting progress information.

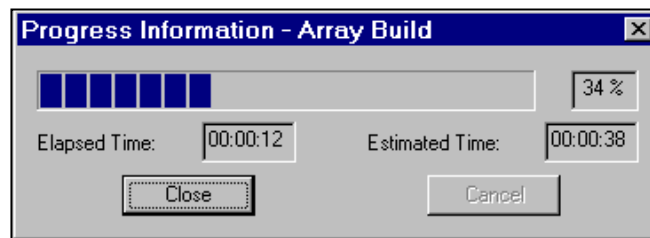

K.5.7 Parity Verify

Click the right mouse button on the Array Drive icon.

RAID 4 and RAID 5 drives contain parity information, which is used in case of a drive failure. The parity information is calculated from the user data on the disk array. On RAID 4 disk arrays the parity data is stored on a single disk (parity disk), on RAID 5 disk arrays the parity data is being distributed over all drives (parity striping). This option verifies online the parity information of the selected RAID 4 or RAID 5 Array Drive. If this option is selected for several Array Drives, the processes are put into a queue and performed one after the other.



If a parity error is detected, you should try to find the reason for this data corruption. A good indication for data corruption can be retries on the SCSI bus. If the retry-counter shows high numbers, this might be the problem. Possible reasons for parity error are bad cabling or termination or a hardware error like a defective drive or a drive which is overheated. **After** removing the reason of the data corruption you can carry out parity recalculate to ensure that the parity information of this disk array becomes again valid.

K.5.8 Parity Recalculate

Click the right mouse button on the Array Drive icon.

A parity recalculate can be used to repair parity errors which have been previously detected with a parity verify. A parity recalculation initiates the same process as used for a build on

an Array Drive. The user data on the drives is read, parity information is calculated from this user data and the parity information is written anew.

While the parity recalculate is in progress the array is in the build state. During this time the Array Drive is not redundant. You can view the progress of the build process by when you click the right mouse button on the Array Drive icon and select progress information.

After the parity recalculate is completed the Array Drive's state changes again into ready with the addition '/patch'. This notification has no relevance for the operation of the Array Drive but is a reminder that the parity information of this Array Drive has been recalculated once.

K.5.9 Progress Information

Click the right mouse button on the Array Drive or Physical Drive icons.

The progress information window shows the progress (elapsed time, estimated time, percentage of completion) of a parity verify, a disk array build or a surface check. During an Array Drive rebuild, the information (user data and/or parity) of a specific Logical Drive is calculated from the user data and parity information of the other Logical Drives and written to this new Logical Drive. During a build of an Array Drive parity information is calculated and written to a specific Logical Drive (RAID 1/4) or striped over the Array Drive (RAID 5). The estimated time indicates the time needed by the controller to finish this process if the user load on the controller does not change. The elapsed time is reset when opening the window.

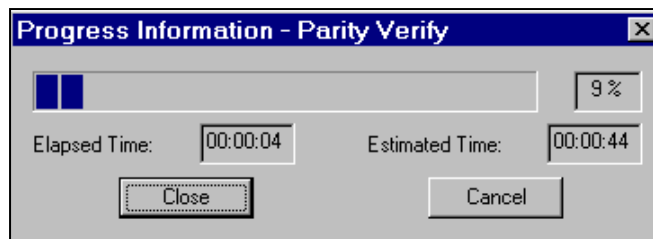

K.5.10 Expansion of an Array

Click the right mouse button on the Array Drive icon.

There are two fundamental functions which are available within this option:

Migrate the RAID level of the selected RAID Array Drive (RAID 0-> RAID 4 and vice versa, RAID 0 -> RAID 5 and vice versa) and/or

Expand the capacity of the selected Array Drive by adding one or several new hard disks.

Both functions can be selected at the same time. E.g., migrate from RAID 0 to RAID 5 and add a new drive. To initiate a migration or expansion with a RAID 4/5 Array Drive, the state must be ready. The data on the Array Drive remain intact and are not affected by the expansion. The additional capacity is introduced as new Host Drive. If a Logical Drive fails during the expansion, the expansion process continues until the expansion is finished. The Array Drive changes into the fail state. The new capacity is available as a new Host Drive. Windows NT (Tool: Disk Administrator) and Novell NetWare ("Scan for new Devices" and then Tool: Install) allow the online integration of new disk capacity. Depending on the RAID level the current Array Drive has, selecting a different one here, will cause the Migration of the RAID level of the Array Drive. If you select the same RAID level, the following procedure will expand the capacity of the Array Drive, only.

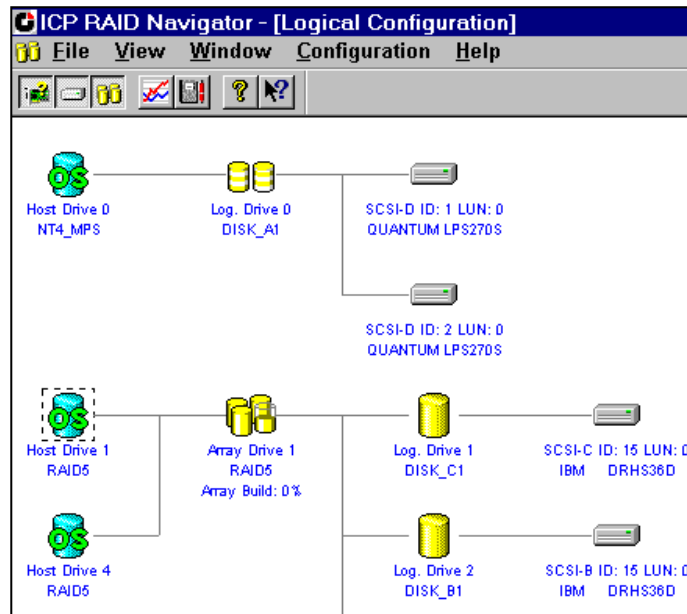

If you want to add additional drives to the Array Drive, select them from the box on the left side of the window. It is possible to add more than one drive at the same time. If no Physical Drives are offered, you have to use the Hot Plug: Add Disk function first, to add new drives. You can open the progress information window to monitor the progress of the expansion. If you have previously limited the capacity of the Array Drive, you are asked, if you want to convert this free space to a new Host Drive.

IMPORTANT: Before starting an expansion it is absolutely necessary to verify that you have a valid backup of the complete data on the system. The expansion process includes a new, unknown hard disk. If there are problems with this disk or with the cabling of this disk there is always the risk of data loss. Some expansions will take quite a long time, so it is advisable that there is not too much traffic (i.e., user load) on the system, otherwise an expansion of a large Array Drive can easily take days.

K.5.11 Add a Hot Fix Drive

Click the right mouse button on the Array Drive icon. Use this option to add a Hot Fix Drive to an Array Drive (RAID 1/4/5/10). You can choose if you want to add a Private Hot Fix Drive or a Pool Hot Fix Drive. Private Hot Fix Drives are assigned to a specific Array Drive and are activated if a member of this Array Drive fails. Pool Hot Fix Drives can be used by any Array Drive with enabled Pool Hot Fix Access. RAID 1 Array Drives allow only Pool Hot Fix Drives. After choosing the type of Hot Fix Drive you can select a Physical Drive from the box which shows all suitable drives.

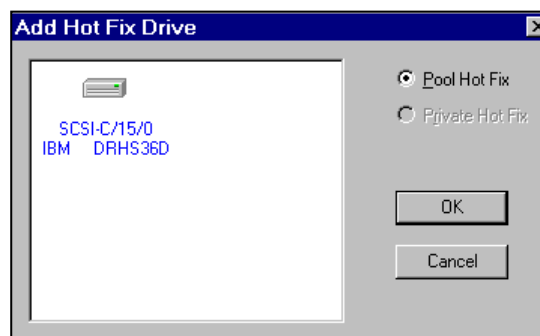

The capacity of the Hot Fix Drive has to be larger or equal than the capacity of the components of the Array Drive (Example: The Logical Drives of the Array Drive have 4.2GB capacity, thus the capacity of the Hot Fix Drive has to be 4.2GB or larger).

The spindle motor of the Hot Fix Drive is normally (i.e., when the Hot Fix Drive is not needed) stopped. Thus, it may take a few seconds until you get a response, if you click on that drive.

Some general notes on Hot Fix Drives.

One of the reasons that have led you to choose RAID disk arrays definitely lies with the redundancy, that is, the data security you still preserve even in the event of disk failure, thus resting assured against loss of data and time. Hot Fix Drives are possible with all RAID 1, 4, 5 and 10 disk arrays. In order to assist the following considerations, we define the term time without redundancy, TWR. Set apart the time needed to set up the disk array (state build), the time without redundancy should be kept as short as possible. Let us assume that one of the hard disks of the RAID 5 disk array we set up with example 1 fails. The disk array is without redundancy. TWR starts to run. Any superfluous prolongation of the TWR (because you have to get a replacement drive, or because you did not realize the failure immediately since you didn't hear the ICP Controller's alarm signal, or because nobody checked the file server) increases the risk of data loss which will occur if a second drive should fail. Therefore, new redundancy should be created as soon as possible and in an entirely automated manner. Integrating a Hot Fix Drive as an immediately available and auto-replacing drive is the only way to keep the TWR as short as possible. Only a Hot Fix drive can ensure optimal disk array security and constant data availability. Of course a Hot Fix Drive is not compulsory. If you control the disk array at regular intervals and immediately replace a defective drive (by shutting down the system or hot-plugging), you can do without a Hot Fix Drive.

K.5.12 Remove a Hot Fix Drive

Click the right mouse button on the Array Drive icon.

This option opens a box showing available Hot Fix Drives. Here you can select the Hot Fix Drive you want to remove from the Array Drive and then confirm your selection. You can remove any Pool Hot Fix Drives or the Private Hot Fix Drive of the selected Array Drive.

K.5.13 Hot Fix Pool Access

Click the right mouse button on the Array Drive icon.

Here you can enable or disable the access of an Array Drive to the pool hot fix of Hot Fix Drives. If the access is enabled this means that if a member of an Array Drive fails, a drive can be taken from the Hot Fix Pool and build automatically into the Array Drive. To be able to activate this feature, there must be suitable Logical Drives in the Hot Fix Pool. You can add drives to the Hot Fix Pool with the function Add Hot Fix Drives. By doing so, the Hot Fix Pool access for this specific Array Drive is activated automatically. For all other Arrays Drive you have to activate the access manually.

K.5.14 Add a RAID 1 Component (Mirror a Drive)

Click the right mouse button on the Logical Drive icon.

In certain "emergency" cases this is a very powerful and helpful option. This function allows you to add to a Logical Drive which is member of an Array Drive, another Logical Drive as a mirror drive (RAID 1).

Example: You have configured an Array Drive with 4 Logical Drives. One Logical Drive has failed and the Array Drive went into the fail state. Another failure would cause data loss. Unfortunately, you find another Logical Drive, which is shortly before failing (e.g., you hear a strange noise from it, or it's grown defect counter explodes). If you now initiate a hot plug it is very likely that this critical Logical Drive will also fail. This would result in a disaster.

To avoid that problem, you can mirror in a first step a new good Logical Drive to the critical one. When the copying is finished you remove the critical Logical Drive and then carry out a hot plug procedure.

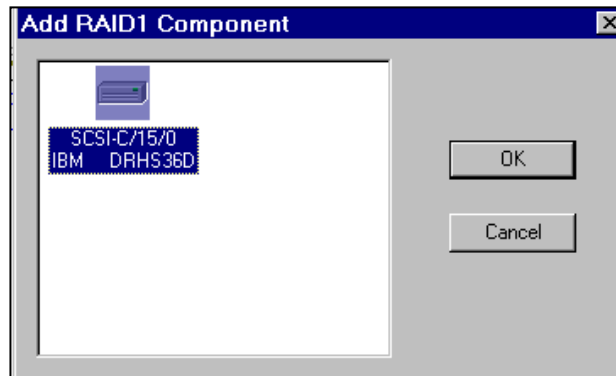

To add a RAID 1 component you need to select in a first step a Logical Drive, the master. All suitable Logical Drives (with a capacity equal or larger than the capacity of the master) are shown in a box. Now choose the Logical Drive you want to add, the slave. After confirming, a new RAID 1 Array Drive is build, i.e., all data from the master are copied to the slave drive(s). When this process is finished all Logical Drives in the RAID 1 Array Drive are identical (there is no longer a difference between master and slave).

K.5.15 Remove a RAID 1 Component (Remove a Mirror Drive)

Click the right mouse button on the Logical Drive icon.

Here you can remove a drive from a RAID 1 Array Drive. If the Array Drive is in the build or in the fail state, you may only remove invalid RAID 1 components.

To remove a Logical Drive from a RAID 1 Array Drive you have to select the Logical Drive you want to remove. This is done by selecting a Logical Drive from a box where you see all members of the RAID 1 Array Drive. After confirmation the Logical Drive is removed. If the RAID 1 Array Drive consists of two drives (like usual) the RAID 1 Array Drive disappears and only one Logical Drive will be left. You can create a new RAID 1 Array Drive by selecting add RAID 1.

K.5.16 Replace a Logical Drive

Click the right mouse button on the Logical Drive icon.

If a Logical Drive of an Array Drive without a Hot Fix Drive should fail (or is very likely to fail, soon), you should replace the defective hard disk with a new one as soon as possible, because the Array Drive is without redundancy. The replacement Logical Drive has to have at least the same capacity as the failed one. The replacement is carried out with ICPCON or the ICP RAID Navigator. Before the Logical Drive can be removed, you have to select a new Logical Drive from the box with available Physical Drives which is shown after this option is selected. If no Physical Drive is offered, you have to use the Hot Plug: Replace Drive function to add a new drive. After the confirmation, the old Logical Drive is removed. Next, the data is rebuild on the new Logical Drive. During this process the array is in the rebuild state and therefore not redundant.

K.5.17 The Different States of an Array Drive

The ready state



RAID 1



RAID 4/5

The Array Drive is fully operational when in the ready state. All redundant information is present, that is, a hard disk can fail without impairing the functionality of the Array Drive. This is the normal state of an Array Drive. The state ready/expand indicates, that the RAID level and/or capacity are currently migrated/expanded.

The idle state



RAID 4/5

This state is characterized by the fact that the redundant information of the Array Drive has never been entirely created. The Array Drive is in this state after its first configuration. If an error should occur while the array is in the build state, the array returns to the idle state (exception: if during build mode the dedicated drive of a RAID 4 Array Drive fails, the state changes to fail).

The build / rebuild state



RAID 1



RAID 4/5

After the Array Drive has been configured for the first time, and the build process is started it assumes the build state. While the Array Drive is in the build state, redundancy information is calculated and stored to the components of the Array Drive.

The disk array will assume the rebuild state after the automatic activation of a Hot Fix Drive or after a manual replacement (Hot Plug). The data and the redundant information are reconstructed and stored to the new drive.

In both states, the Array Drive is not redundant.

You can monitor the progress of the array build/rebuild by clicking the right mouse button on the Host Drive and then selecting progress information.

Note: User traffic on an Array Drive which is in the build/rebuild state, slows down the build/rebuild process.

The fail state



RAID 1



RAID 4/5

The Array Drive changes to the fail state whenever a Logical Drive fails. Redundancy information is still present, thus allowing the remaining hard disks to continue working. This state should be eliminated as soon as possible by replacing the defective hard disk. This can be done by using a Physical Drive, which is already connected with the controller, but not yet used for a Logical Drive, with the replace drive function, or by using the Hot Plug Replace Drive function. If a Hot Fix Drive has previously been assigned to an Array Drive, the ICP Controller will automatically replace the defective drive and start the reconstruction of the data and the redundant information. Therefore, under these circumstances the fail state is only temporary and will be eliminated by the controller itself.

Whenever an Array Drive enters a fail state, the ICP Controller's audible alarm is turned on. You can silence the audible alarm in the physical configuration window.

To analyze the reason for the drive failure, the last status from the Physical Drive information is very helpful. Additionally you should check for retries and/or reassigns.

A drive failure may also be the result of bad cabling, wrong termination or overheating.

The error state



RAID 4/5

If a second hard disk should fail while the Array Drive is in the fail or rebuild state, it is not possible to continue the working session without restrictions. The disk array is still available for I/Os, but data loss and error messages on the host level are possible.

Usually you have to remove the Array Drive and build a new one. In some situations (see below) there might be still a chance to reset the array. Please contact our support departments.

To find out why the drives failed, the last status from the Physical Drive information is very helpful. Additionally you should check for retries and / or reassigns.

A drive failure may also be the result of bad or cabling, wrong termination or overheating.

Some of these states may become the addendum patch (e.g. build/patch, ready/patch). This word indicates that the original Array Drive went through a significant procedure. I.e., the parity information was recalculated anew. Or, the Array Drive has been patched from the error state into the fail state. This may become extremely helpful in a situation where two Logical Drives of an Array Drive, fail at the same time, but only one of the two Logical Drives is really defective and the other was blocked out, since it was connected with the same I/O channel as the defective one. The Array Drive's state is error and normally all data would be lost. The ICP Controllers include some functions, which allow the patch of this Array Drive from the error state into the fail state. Before the actual patch, the defective drive has to be physically removed from the Array Drive. Such a patch-procedure is a real sheet-anchor and should only be used, after a detailed consultation with a trained support person (a printout of the Save Information file, is extremely helpful).

K.6 The Statistics Window



The statistics window can display the throughput of Physical, Logical and Host Drives. The vertical axis show the throughput, the horizontal axis the time. You can add drives by drag and drop them from the physical and logical configuration windows into the statistics window. If you want to change the layout of the lines, adjust the scales of the axis or remove drives from the statistics windows, you can do this using the chart menu.

You can scale the statistics window using the cursor keys:



scale time down/up





scale throughput



K.7 The Controller Events Window



This window shows the history of the events that occurred since the log was cleared the last time. The first column in this window contains icons representing the severity of the events:

Icon	Description
	Information: This event is not critical. It only informs the system administrator about certain events, like the completion of an array build.
	Warning: This event is critical and may not be ignored. It occurs for example if an Array Drive's state changes from ready to fail.
	Error: An error occurred. This might be the failure of a drive.

The second column lists how often this event occurred. Some events may occur quite often, so this counter helps to keep an overview. The next column lists the date and the time when the event occurred. The last column describes the event. At the bottom of the window there is the Settings button. Here you can change the polling interval and enable the auto save function. Logs that are not saved on the hard disk are lost when the system is reset. The auto save function saves the current log in the time intervals selected there. The default name for this logfile is 'gdtevt.evt'. The Save As button allows you to write the contents of the event log to a specific file on the hard disk. The Load button loads an older event log and displays it. The last two buttons delete the log file and clear the event buffer on the ICP Controller.

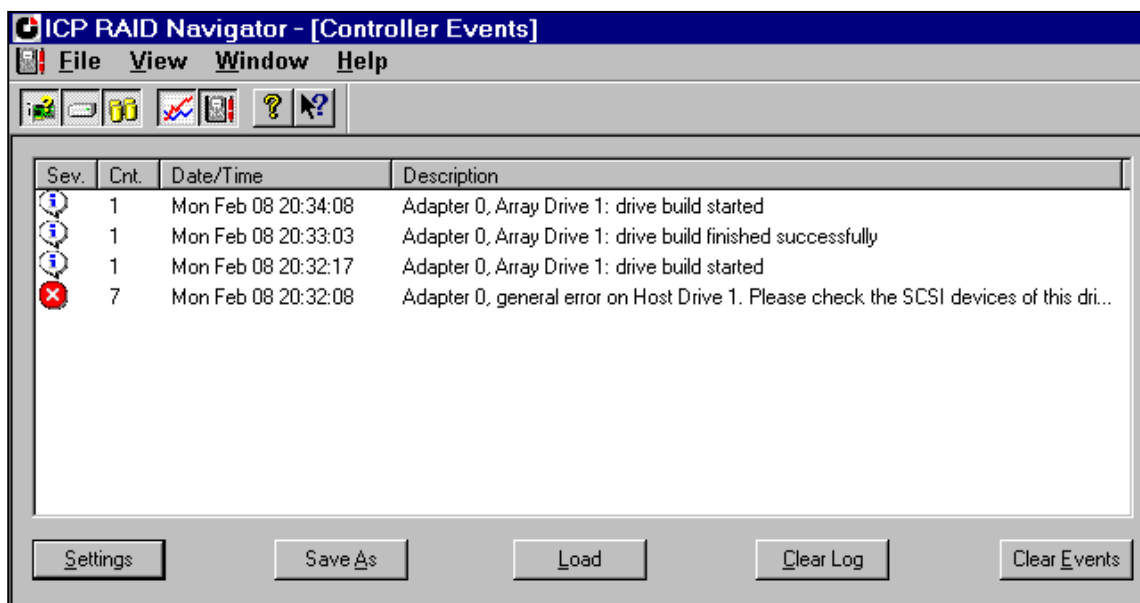

K.8 ICP RAID Navigator Help

The ICP RAID Navigator includes an online help function. You can either choose the Help menu or the pointer with the question mark to obtain online help on a specific icon or function. There is also an index which allows you to search for certain keywords and/or topics.

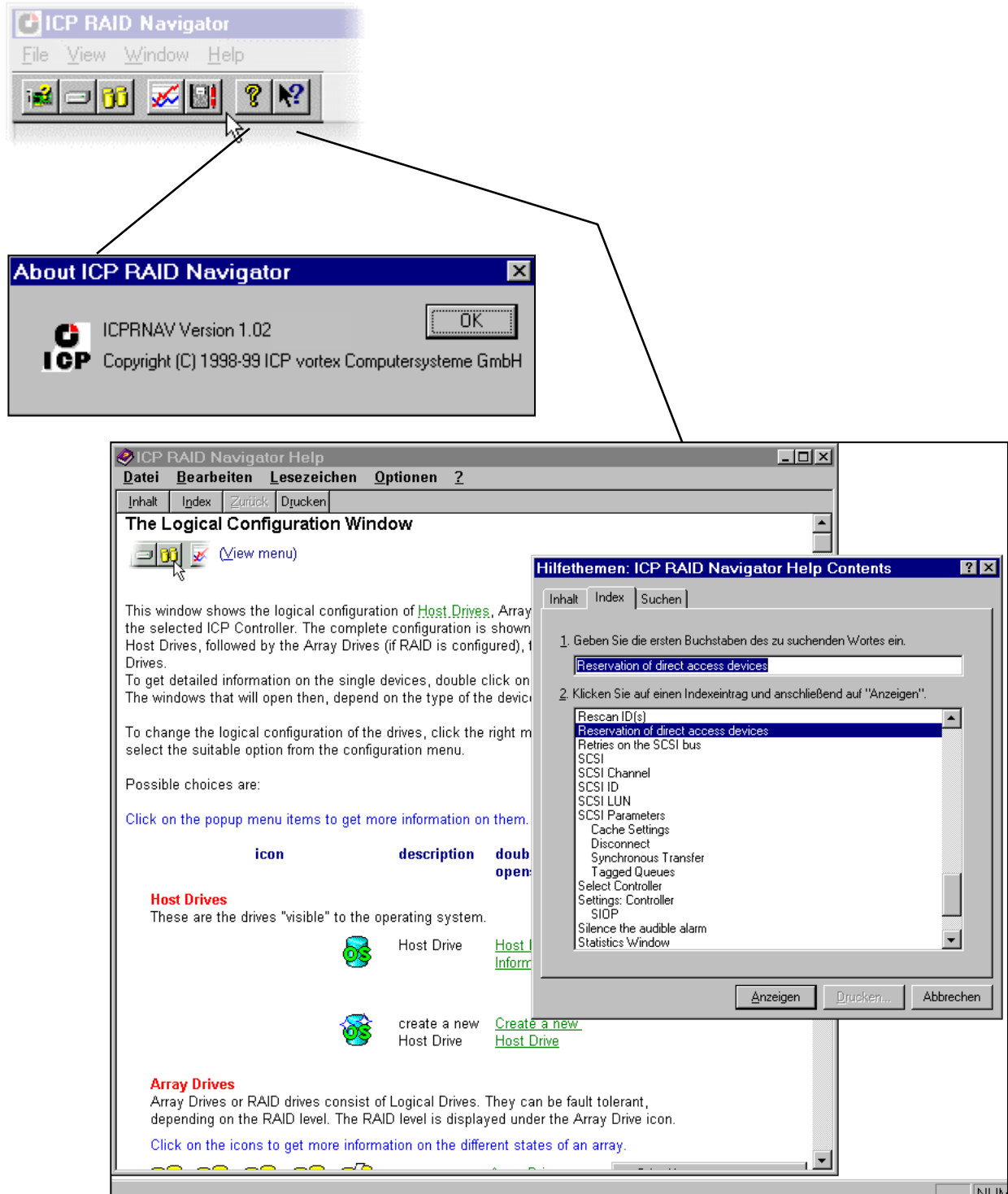

K.9 ICP Service and ICP Mail

There are further powerful tools which are part of the ICP RAID Navigator delivery:

ICP Service	Allows remote access to an ICP Controller in a Windows NT server
ICP CTRLSRV	Allows remote access to an ICP Controller in a Novell Server
ICP Mail	Converts ICP messages into standard mails (for Windows 9x/NT, MAPI format)

It is recommended to install the ICP Service / ICP CTRLSRV and the ICP Mail tool on each server which is equipped with an ICP Controller. Thus, remote access to ICP Controllers in a network can be easily managed from one or several authorized users.

To install the ICP Service under Windows NT, copy ICPSRV.EXE and ICPSRV.CPL into the winnt\system32 directory and load

```
..\ICPSRV -i
```

from the command line. This installs the service. In a next step load in the "control panel" the "services" program and activate the ICP Service with the Start button.

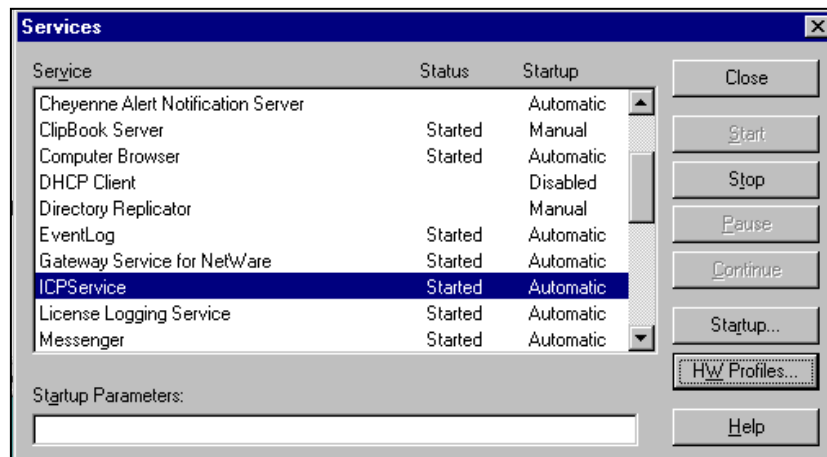

If you want to start the ICP Service during every new boot of the system automatically, click on the Startup button.

To configure the ICP Service double click on the ICP Service icon:

- The Poll-Interval determines the time between two message acquisitions of the ICP Service.
- Under Workstation you can add workstations which receive broadcast messages from the ICP Controller.
- In the device driver section you can add or remove parameters for the gdx.sys driver (e.g., reserve parameters for raw devices).

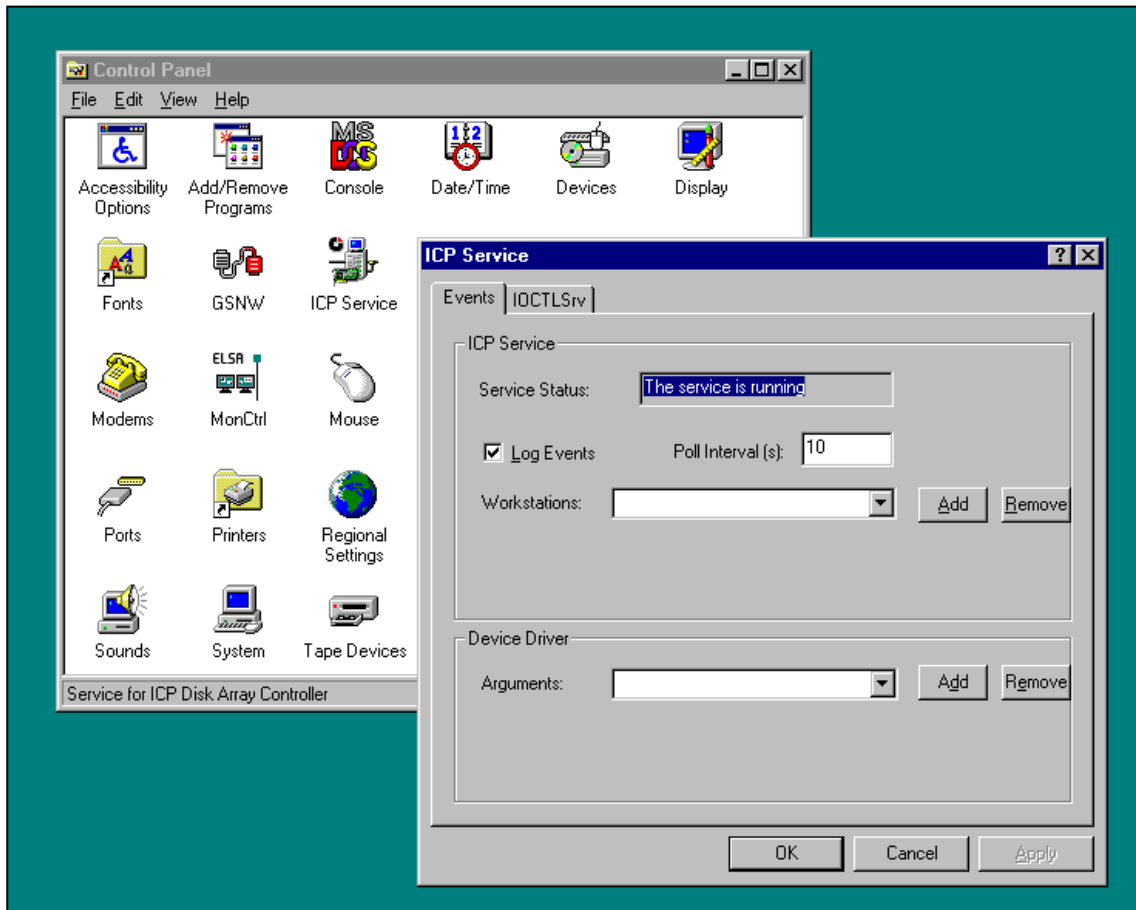

In the IOCTLSrv property sheet you can add / remove users which have remote access to the ICP Controller with the ICP RAID Navigator. Passwords are encrypted.

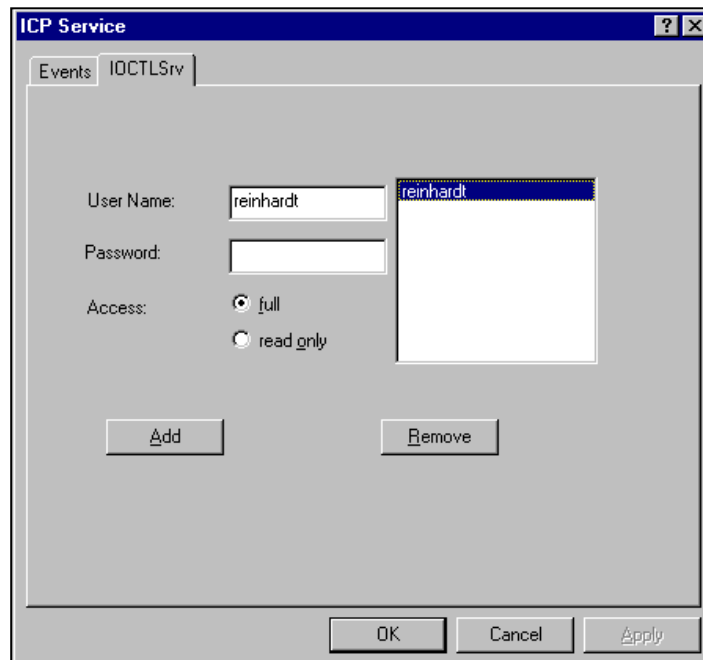

The ICP Mail tool gathers messages from the ICP Service, generates standard mail messages and sends them to pre-defined workstations.
After loading ICPMAIL.EXE and selecting "Settings", you can configure the mailing tool.

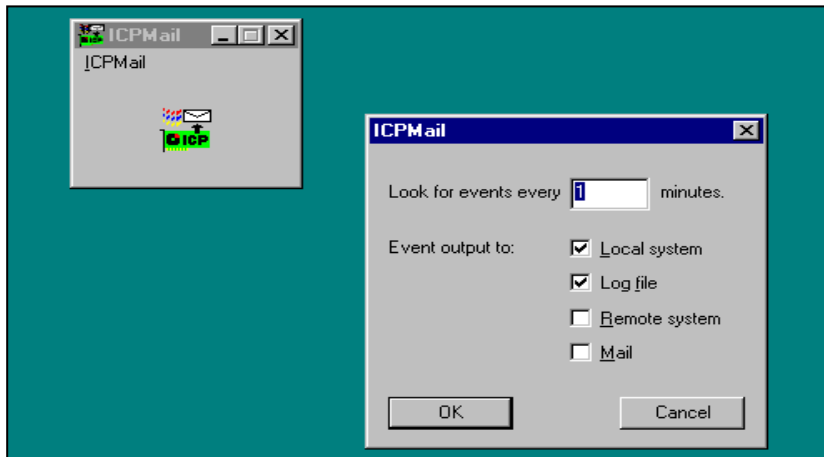

If you select "Local System" all messages are displayed on the server itself.
If you select "Log file" you are asked for a log file path/name. All messages are recorded into this file.

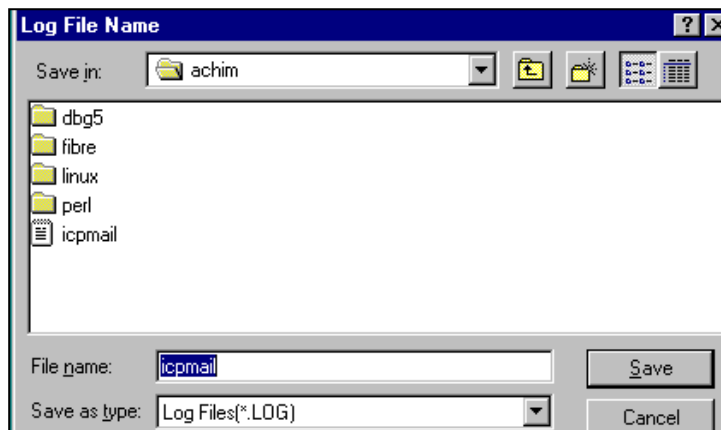

"Remote System" allows you to add workstations to which messages are send.

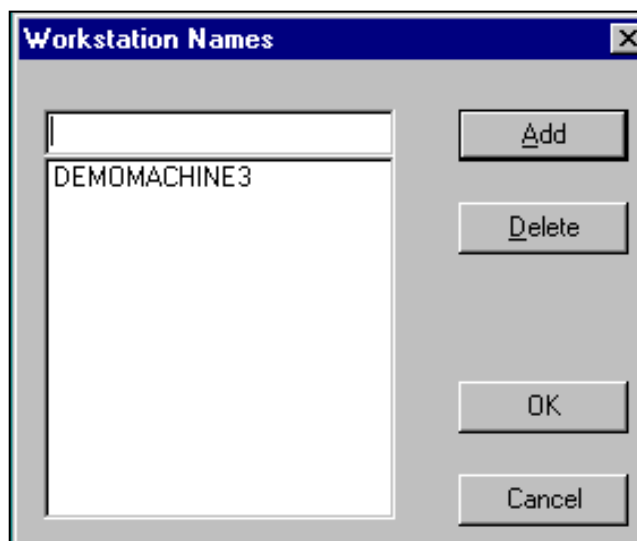

Following is a typical message generated by ICP Mail.

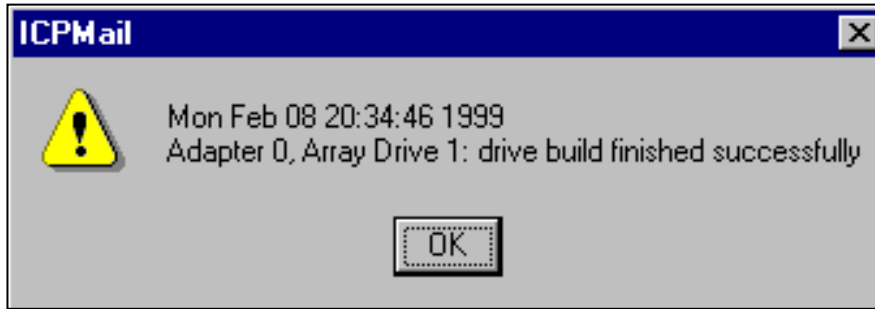

The "Mail" option allows the interfacing to a standard mailing system (like Microsoft Outlook or Exchange).



Chapter L

Appendix

L. Appendix

L.1 Technical Data of the ICP Controller

Board Size	Standard PCI long card format or 2/3 hereof
PCI Bus	32 Bit / 64 Bit 33MHz, 5 Volt
Weight	0,35 kg
Temperature Range in Operation (measured in the enclosure)	10° to 55° C or 50° to 131° F
Temperature Range not in Operation	-10° to 60° C or 14° to 140° F
Humidity in Operation	20% to 75% not condensing
Maximum Altitude in Operation	3000 meter or approximately 10.000 feet
Power Consumption (5V, 12V)	approximately 10 Watt

L.2 Boot Error Messages

<u>Error Message</u>	<u>possible cause, remarks</u>
"Error detected on SIOP x"	SCSI cable defective hard disk connected defective SIOP x defective SCSI bus not properly terminated termination power missing
"Memory error detected":	Memory Module defective

Memory errors of the ICP Controller are also indicated acoustically with the audio alarm of the ICP Controller (3 beeps repeated every 10 seconds).

The following audio alarm sequence indicates that the ICP Controller is tried to be operated without a DIMM: "beep-beep-short_pause-beep-beep-long_pause-beep-beep-short_pause-etc.". All ICP Controller require a memory module for operation.

L.3 Index

- 32 Bit PCI bus-master slot 48
- 64 Bit PCI bus-master slot 48
- Acoustical Alarm 63, 142
- Acoustical Alarm, RAM failure 184
- Activate the primary DOS partition 72
- Architecture, 64 Bit 22
- ASPI 60, 74
- ASPI Interface 74
- ASPI Manager 74, 76
- ASPI module 74
- ASPIDISK.SYS 77
- ASPISCAN.EXE 76
- ASPITRAN.DSK, ASPI Layer 82
- ASW ASPI module 77
- Backup 6
- BBS - Mailbox 19
- Cache algorithm 22
- Cache RAM 22, 36
- Cache RAM detection, automatic 18
- CD-ROM Drive 74
- Cluster RAIDYNE firmware 23
- CMOS components 21, 36
- corelSCSI 59, 74, 75
- CTPCI, c't magazine PCI tool 73
- CTRLSRV.CFG 117
- CTRLSRV.NLM 117
- CTRLTRAN.DSK 82
- Deinitialize Disks 136
- Differential SCSI 37
- Disk Array, Maximum Number of Drives 65
- Disk Arrays, Build State 67, 125
- Disk Arrays, Error Status 67, 126
- Disk Arrays, Expand State 67, 126
- Disk Arrays, Fail State 67, 125
- Disk Arrays, Hot Fix Mechanism 66
- Disk Arrays, Idle State 67, 125
- Disk Arrays, Level of Redundancy 66
- Disk Arrays, Minimum Number of Drives 65
- Disk Arrays, Phase Diagram 67
- Disk Arrays, RAID 0 119, 140
- Disk Arrays, RAID 1 17, 54, 66, 119
- Disk Arrays, RAID 10 17, 119, 140
- Disk Arrays, RAID 4 17, 54, 55, 66, 119, 140
- Disk Arrays, RAID 5 66, 119, 140, 142
- Disk Arrays, Ready State 67, 125
- Disk Arrays, Rebuild State 67, 126
- Disk Duplexing 63
- Disks, Initialization 59
- DPMEM - Dual Ported Memory 50
- error messages 184
- Examples for SCSI cabling 46
- Expanded Memory Manager 73
- Factory setting of jumpers 25
- FAST-40 37
- FAST-80 37
- Fast-SCSI Bracket 44
- FCC Compliance 7
- Flash-RAM 18, 20, 22, 131
- GDT ASPI Manager, GDTASPI.EXE 76
- GDT_RPFW, file 131
- GDTASPI.EXE, Parameters 76
- GDTRP310.DSK, Driver vor NetWare 3.10 82
- GDTRP311.DSK, Driver for NetWare 3.11 82
- GDTRP312.DSK, Driver for NetWare 3.12 82
- GDTRP400.DSK, Driver for NetWare 4.x 83
- GDTX.SYS, Driver for Windows 2000 94
- GDTX.SYS, Driver for Windows NT 90
- GDTX000.EXE, Driver for MS-DOS 72
- Grown Defect List 136
- Hardware Installation of the ICP Controller 36
- Hierarchy, Level 1, Physical Devices 59
- Hierarchy, Level 2, Logical Drives 59
- Hierarchy, Level 3, Array Drives 59
- Hierarchy, Level 4, Host Drives 59
- Host Drives 59
- I₂O ready 18
- I₂O Special Interest Group 19
- i960RN/RS 18
- ICP boot message 50
- ICP CDROM 21
- ICP Controller Configuration 51
- ICP Controller of the RN Series, Ultra 160 SCSI 17
- ICP Controller of the RN Series, Wide/Ultra 160 SCSI 17
- ICP Controller of the RN Series, Wide/Ultra2 SCSI 17
- ICP Controller of the RS Series 16
- ICP RAID Console 18, 22, 116
- ICP RAID Navigator 18
- ICP SCSI Accessories 44
- ICP vortex Computersysteme GmbH 19
- ICP vortex Corporation 19
- ICPCON, Grown Defects 123
- ICPCON, Last Status information 123
- ICPCON, Save Information 123
- Installing the ICP Controller, Trouble Shooting 51
- Intel i960RN/RS 22
- Internet - E-Mail 19
- IPX, NetBIOS, TCP/IP 23
- Jumpers and LED connector 25
- LEDs of the GDT controller 49
- Levels of Hierarchy 59
- LVDS/SE Terminator 45
- LVDS/SE Terminator for SE/LVDS Hard Disks with SCA Connector 45
- Mirroring-Array 63
- mkdev, SCO UNIX 3.2v4.x 105
- MSCDEX, CD-ROM extension 75
- Narrow-Wide-SCSI Bracket 45
- NCPE Protocol 116

- NETBIOS Protocol 116
NetWare, Cache Memory Allocator 85
NetWare, Optimize Throughput 85
NetWare, Tips & Tricks 85
Nonbuffered PC100 DIMM 36
Not Direct Access Devices 60, 76, 106
Novell Orion® Cluster 23
NT Advanced Server Variant 90
Online Capacity Expansion 17
Operating System Drivers 25
Partitioning a Host-Drive 72
PCI 2.2 compliant 22
PCI compatibility 18
PCI INT A 50
Primary Defect List 136
Quick-Setup 54
RAB, RAID Advisory Board 19
RAID 0 - Definition 56
RAID 1 - Definition 56
RAID 10 - Definition 58
RAID 4 - Definition 57
RAID 5 - Definition 57
RAID functions 22
RAIDYNE firmware 23
RAIDYNE® 22
README.TXT File 21
Replace Drive with ICPCON 141
SCA connector 46
SCO UNIX, GDTSYNC 109
SCSI Basics 37
SCSI Bus Termination 43
SCSI Cables 38
SCSI ID 43
SCSI RISC processor 18
SCSI Wonder 45
Single Ended SCSI 37
Software License Agreement 20
Standard firmware 23
Swap Host Drives 128, 146
Synchronous Transfer 135
Technical Support 5
Ultra SCSI 37
Ultra160 SCSI 37
Ultra2 SCSI 37
UnixWare BTL Disk 112
Using Microsoft MS-DOS 72
Using Microsoft Windows NT 90
Using Novell NetWare 82
Using SCO UNIX V/386 104
Using UnixWare 112
Using Windows 95 78, 80
Virtual DMA Services 72
Warranty 4
What is the ICP Controller Firmware 54
Wide & Ultra SCSI 18
Wide/Ultra SCSI Flat Ribbon Cable 44
Wide/Ultra2 37
Wide-SCSI Adapter 44
Wide-SCSI Bracket 44
Windows 2000 94
Windows NT, Master Boot Record 91
Windows NT, Raw Devices 93
Windows NT, Updating the GDTX.SYS driver 93